

General Purpose CO2 Laser Machines

Laser System Manual



GU Eagle America, Inc.
<http://www.gueagle.com/>

Contents

- List of Tables..... v
- List of Figures..... vii
- Abstract..... 9
- Chapter 1: Safety..... 11**
 - Fire Warning..... 12
 - Laser Safety..... 12
 - Electrical Safety..... 13
 - Do and Don't..... 13
- Chapter 2: Quick Start Guide..... 15**
 - Unpacking..... 16
 - Mechanical Installation..... 17
 - Startup..... 21
 - Calibrate Laser Route..... 24
 - Install Software..... 28
 - Create And Send A Job To Machine..... 29
 - Make A Sample..... 31
- Chapter 3: Calibrate Laser Route..... 35**
 - Preparation..... 36
 - Calibrate Laser Route to 1st Mirror..... 36
 - Calibrate Laser Route to 2nd Mirror..... 37
 - Calibrate Laser Route to 3rd Mirror..... 41
 - Check Laser Route..... 45
 - Calibrate Laser Route To Workpiece..... 47
- Chapter 4: Control Panel..... 51**
 - Introduction..... 52
 - Main Interface..... 53
 - File Interface..... 55
 - Settings..... 57
 - Alarm..... 62
- Appendix A: Q & A..... 63**
 - Control System..... 64
 - Laser System..... 68
 - Motion System..... 69
- Appendix B: Electronic Connections..... 71**
 - Servo Motor..... 72



Step Motor.....	73
Revision History.....	75

List of Tables

Table 4-1: Action keys list..... 52



List of Figures

Figure 2-1: List of Parts..... 16

Figure 2-2: Schematic diagrams of laser tube installation..... 17

Figure 2-3: 1st mirror adjust method..... 25

Figure 2-4: 2nd mirror adjust method..... 26

Figure 2-5: 3rd mirror adjust method..... 27

Figure 2-6: Laser route calibration steps..... 28

Figure 2-7: Draw a circle in KTWorks software..... 30

Figure 3-8: Basic law of adjust method of calibrating laser route to 2nd mirror..... 37

Figure 3-9: Basic law of adjust method of calibrating laser route to 3rd mirror..... 42

Figure 4-10: Layout of control panel..... 52

Figure 4-11: Layout of main interface..... 53

Figure 4-12: Layout of file interface..... 55



Abstract

This is a complete reference book for general purpose CO2 laser cutting and engraving machines, include a quick start guide, instructions for calibrating laser route and operating control panel, etc.

This book is organized into several self-contained chapters. You can choose how to use it as your will, read from beginning to end, or focus on contents of your interests.

People who operate or maintain the laser machine should read this book to get to know the machine. And please refer to other manuals for EagleWorks and EaglePrint softwares.



Chapter 1

Safety

Topics:

- *Fire Warning*
- *Laser Safety*
- *Electrical Safety*
- *Do and Don't*

Please read this chapter carefully before startup to avoid any danger or improperly operation.



Fire Warning



DANGER:

Laser machine uses a high intensity beam of light that can generate extremely high temperatures when it comes into contact with the material being cut or engraved. Some materials are extremely flammable and can easily ignite and burst into open flame setting the machine afire. This open flame is very dangerous and has the potential to destroy not only the machine, but the building in which it is housed.

Experience shows that vector cutting with the laser has the most potential to create an open flame. Many materials are susceptible to igniting, but acrylic, in all its different forms, has been shown to be especially flammable when vector cutting with the laser.

Please read the following warnings and recommendations and follow them closely at all times!

- Stay with the laser.

Never operate the laser system while unattended.

- Keep the area clear.

Clean around the machine and keep the area free of clutter, combustible materials, explosives, or volatile solvents such as acetone, alcohol, or gasoline.

- Be prepared with a fire extinguisher.

Always keep a properly maintained and inspected fire extinguisher on hand. G.U. Eagle recommends a Halotron fire extinguisher or a multi-purpose dry chemical fire extinguisher. The Halotron extinguishers are more expensive than a dry chemical, but offer certain advantages should you ever need to use an extinguisher. The Halotron extinguisher discharges a clean, easily removable substance that is not harmful to the mechanics or wiring of the laser system. The dry chemical extinguisher discharges a sticky, corrosive powder that is very difficult to clean up.

- Use Air Assist.

Always use the system's air assist feature when vector cutting.

- Use caution when vector cutting.

Many materials have the potential to suddenly burst into flames when cut with a laser – even materials that may be very familiar to the user. Always monitor the machine when it is operating.

- Clean the laser.

A buildup of cutting and engraving residue and debris is dangerous and can create a fire hazard in its own right. Keep your laser system clean and free of debris. Regularly clean underneath the working table to clean any small pieces that have fallen through the supporting bars.

Laser Safety

The output of the embedded laser is fully contained. The laser cabinet has safety interlocks that turn the laser off if the front door is opened during operation, and no special precautions are necessary to operate the laser safely.

Access panels are not interlocked. Access panels should always be closed when the laser is operating. Never operate the laser system with an access panel opened.



DANGER:

DO NOT disassemble the machine or remove any of its protective covers while the unit is plugged in.

DO NOT attempt to defeat the door interlocks.

Electrical Safety

The AC input power to the laser system is potentially lethal and is fully contained within the cabinet.



DANGER:

DO NOT open any of the machine's access panels while the unit is plugged in. Opening a panel may expose the operator to the unit's AC input power.

DO NOT make or break any electrical connections to the system while the unit is turned on.

Do and Don't



Warning:

- Do Not Run the Laser Unvented.

Never operate the machine without a properly operating vent to the outside or to a filtration unit! Most material will only produce an irritating smoke when engraved. Some materials, including but not limited to paint, varnish, composition board and plastics, produce compounds that can be harmful if concentrated. A properly installed vent is the only way to ensure that problems do not occur.

- Do Not Engrave or Cut PVC.

Never engrave or cut any material containing PVC or vinyl. When engraved, a corrosive agent is produced that will destroy your machine. Your warranty will be void if your machine is damaged by corrosion from engraving or cutting PVC or Vinyl.

- Do Not Operate Machine While Unattended.

Never operate your machine without someone watching the system. There is a significant risk of fire if the machine is set improperly, or if the machine should experience a mechanical or electrical failure while operating.

- Do Not Vector Cut While Machine is Unattended.

Never laser cut any material with the laser without someone watching the system. Because vector cutting moves relatively slowly compared to raster engraving, a tremendous amount of heat is applied to the material being cut. This buildup of heat can cause significant fire risk and the machine should always be monitored. Additionally, the air assist should always be turned on when vector cutting to reduce the risk of fire.

- Do Not Operate The System While Doors are Open.

Never operate with any of the covers or enclosures removed, and never modify the enclosure. The laser beam is invisible and is very dangerous!

Tip:

- Clean the System.

Please allow a few minutes a week for cleaning your machine. Just a small amount of effort at the end of the week will pay off with years of trouble-free operation of your machine.

Chapter 2

Quick Start Guide

Topics:

- [Unpacking](#)
- [Mechanical Installation](#)
- [Startup](#)
- [Calibrate Laser Route](#)
- [Install Software](#)
- [Create And Send A Job To Machine](#)
- [Make A Sample](#)

This chapter will show you how to unpack your new laser machine, install the laser tube(s) and other parts, install the software, and create your first sample.



Unpacking

Your machine has been carefully packed and shipped in a secure wood-sided shipping crate. Start by disassembling the crate with a screw gun and removing the wood crate parts from the area, leaving only the crate floor underneath the machine.

Remove and set aside all the loose parts—the water chiller, blower, ductwork, miscellaneous parts box, and box or boxes containing the laser tube(s). Pay particular attention not to put weight or stress on the laser tube boxes, as the tubes are made of glass and the cardboard boxes are not designed to protect them from more than light handling.

Rotate all the foot-plates to the fully raised position (rotating anti-clockwise when looking down from above).

The machine is now ready to be lifted off the crate floor. This can be done with a forklift, or with several workers positioned on all sides of the machine (caution, the total weight of the machine is approximately 880 pounds, 400kg).

If using a forklift, you must use fork extensions or sturdy wood planks to span the full width of the machine. Do not attempt to lift with forks that do not reach the far edge of the machine.

If using an overhead crane and lifting straps, a spreader bar must be used to avoid excessive pressure from the straps on the top edge of the machine.

Once the machine is on a level surface, it can be rolled into place on its built-in casters. After positioning, secure it in place by screwing the leveling feet down until they are in firm contact with the ground. Precise leveling of the machine is not necessary, but it should be reasonably level and well-supported with roughly equal pressure on all four feet.

Laser tube(s)



Industrial chiller



Chiller alarm cable



Power cable



Exhaust blower, ducts

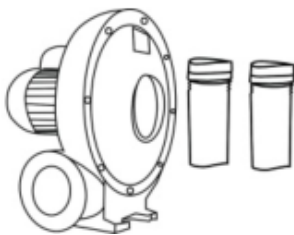

Outlet strip

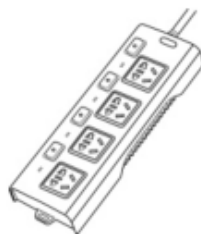

Software, USB cable, tools



Figure 2-1: List of Parts

Mechanical Installation

Once your machine is in its final installation location, the first step is to install the laser tube(s) in the laser housing on the back side of the machine. The sooner the laser is installed, the sooner it will be protected from accidental damage outside the machine!

The figure below shows a schematic diagrams of the CO₂ glass laser tube, the laser housing, and the correct orientation of the laser tube within the housing.

You can recognize the back end (the anode, or + end) of the tube by the glass coil inside the outer glass envelope. The laser beam emerges from the other end of the tube.

On single-tube machines, the back end with glass coil will be on the left when you are facing the back side of the machine. On dual-tube machines, one will face in each direction.

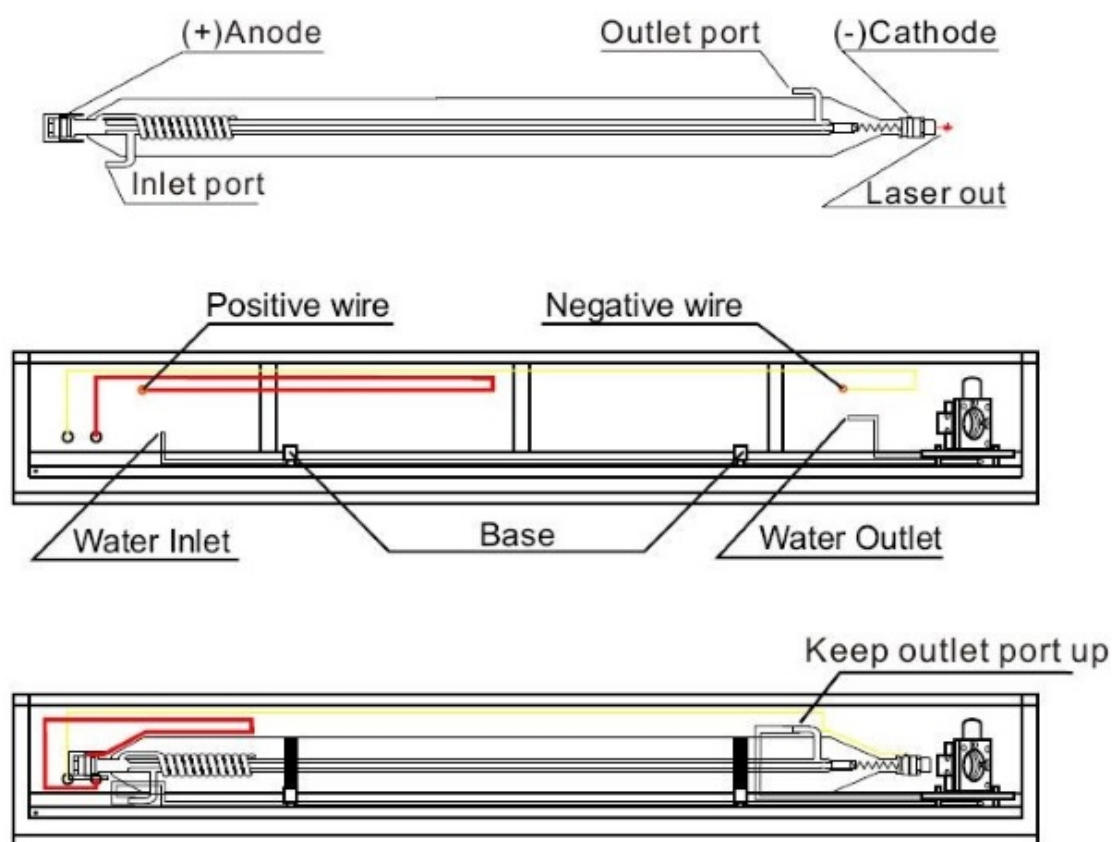

Important:

The water outlet port of the laser tube on the cathode (beam-exit) side must face upwards!

Figure 2-2: Schematic diagrams of laser tube installation

Follow these steps to complete the mechanical installation of the laser tube and other system components.

1. Check the laser tube

Open the laser shipping box, carefully take out the laser tube, and check it for damage. The laser outlet window should be clean and there should be no physical damage to the glass tube.

2. Place the laser tube in the machine

Open the laser housing at the back of the machine and carefully set the laser tube onto its curved supports. The laser output side (the side opposite the inner glass coil) should be facing the angled mirror assembly. On single-laser models this will be to your right, and on dual-laser machines one laser tube will face in each direction.



The laser output window should be about ½” (10-15mm) from the round porthole in the metal bracket on the mirror mount.



3. Connect the water hoses

Locate the two rubber water hoses within the laser housing. Connect one to each water inlet/outlet port at the ends of the laser tube (use the tube nearest each port). Make sure they are well-seated on the ports. (On dual-laser models connect all four hoses, two on each tube.)



4. Rotate the water outlet port to the top

It is very important for proper cooling water flow that the water port on the laser output side of the tube (the side opposite the glass coil) be facing upwards, allowing air to escape once the cooling water flow is turned on. Before fastening the laser tube in place, rotate it so this port is directly on the top side of the tube.



5. Fasten the laser tube in place

Use the provided elastic straps to fasten the laser tube in place. Hook each elastic band to the back side of the curved tube mount, stretch it over the top of the tube, and then hook it onto the front side of the mount. Re-confirm that the water outlet port is facing straight up.

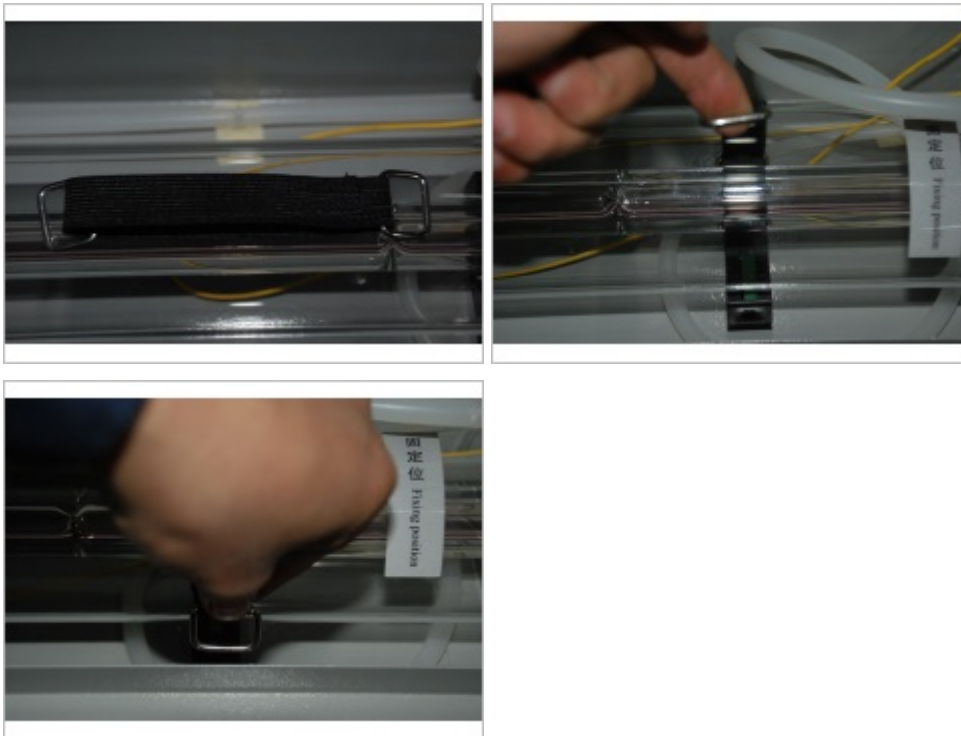

6. Connect the laser power wires

Connect the positive (red) wire you will find inside the laser housing to the screw terminal on the anode (+) side of the laser tube (the side with the glass coil inside). Slide the clear plastic insulation cover away to access the screw, then slide it back in place once the wire is screwed down. (This cover is important to avoid accidental contact with the high voltage that operates the laser tube.)



Connect the negative (yellow) wire to the cathode (-) side of the laser (the side facing the angled mirror). This side does not require an insulated cover.

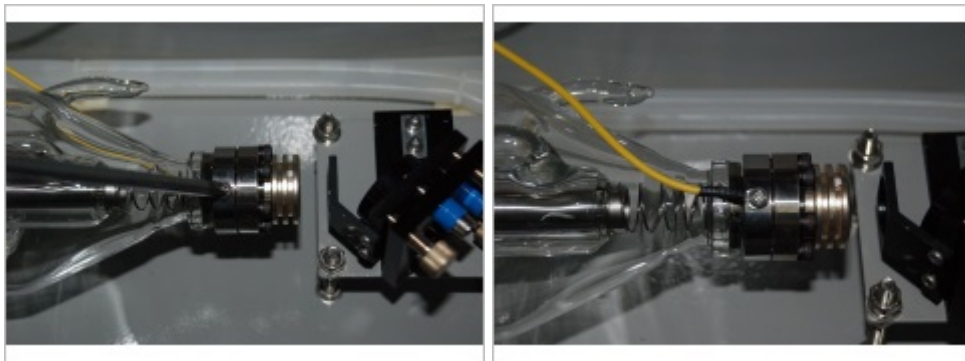

Do Not Over-Tighten The Screws! The screws holding the ground and high voltage wires should be hand-tight. Avoid putting excessive stress on the glass tube or electrical terminals.

On dual-laser models, repeat for the second laser tube. For each tube, use the appropriate color of wire that emerges from the machine housing closest to its respective terminal.

7. Connect the water chiller

Place the water chiller unit in a convenient location near the back of the laser machine. Identify the water hose coming from the outlet port of the laser tube (the one facing the top of the tube, by the laser exit mirror) and connect it to one of the inlet ports on the back of the chiller unit.



Next, connect the inlet port of the laser tube (the one facing down on the side of the tube with the glass coil in it) to the corresponding outlet port on the water chiller.

On dual-laser machines, repeat with the other pair of inlet/outlet ports.

On single-laser machines, if your water chiller unit has a second pair of inlet/outlet ports, connect them to each other with a short length of rubber tubing about 6" or 15cm long. (You can cut a short length off one of the supplied water hoses for this purpose.)

8. Connect the chiller alarm

Connect the water chiller alarm cable from the connector on the back of the chiller unit to the alarm connector on the back of the laser machine.

9. Install the exhaust blower

Place the exhaust blower in a convenient location near the back of the machine. Use the supplied flexible duct and hose clamps to connect both air ports on the back of the machine to the supplied T connector, and from there to the center inlet port of the blower unit. Use the supplied flexible duct, or any 6" (15cm) flexible or rigid duct of your choice, to vent the bottom outlet port of the blower to the outside. Note that venting is very important: the machine cannot be operated without adequate venting to the outside! (In situations where this is not possible, we offer an optional air purification system.)



10. Complete electrical hookup

Install the power cord on the back of the main laser machine, then connect the laser machine power cord, blower power cord, and water chiller power cord to the supplied switched power outlet strip. Connect the outlet strip to a 220V, 15A capacity electrical outlet, making sure to follow all local electrical and fire safety codes.

Congratulations, you have completed the mechanical installation of your new laser machine! The next section will show you how to power it up and verify basic operation of the major components of the system, including the X-Y motors, water chiller, blower, and the laser tube(s).

Startup

Now that you have finished the mechanical setup of your machine, you are ready bring it up to operational status. Please follow these steps in order to ensure safe and reliable startup.

It is convenient to start with the supplied power outlet strip plugged in to an appropriate 220V, 15A circuit, switched on, but with nothing plugged into it. You will be plugging the components of the system into this outlet strip one by one as they are brought online. (After

the machine is operational, you can use the master switch on the outlet strip to switch all the components on and off together.)

1. Add cooling water

Fill the water chiller unit with distilled or deionized water through the filling port on the top of the unit (the commonly available variety used for ironing is fine). You will need about 2 gallons or 8 liters. A sight glass on the back of the units lets you verify when it is full.



2. Test the water loop

Plug the water chiller into the outlet strip and switch it on. Watch the laser tube to verify that it fills with water, and confirm that any air bubbles work their way out through the outlet port. If water comes in through the top of the tube, it means the tubes are hooked up to the wrong ports: interchange the inlet and outlet ports on the water cooler.

Check carefully for any leaks in the water system and shut off the power immediately if you see any water entering the laser machine.

If the water chiller sounds its alarm, check for kinks in the water hoses. (It is normal to hear the alarm for a fraction of a second when it is first switched on.)

The water chiller is configured by default to keep the water at 2°C cooler than the ambient air temperature: the water will not feel cold even though the unit is operating correctly. (This provides adequate cooling while preventing harmful condensation on the water lines or laser tube.)

3. Power up the laser machine

Plug the main laser machine power cord into the outlet strip and switch on the laser machine circuit breaker and power switch.

You should see the control panel light up, and the X-Y motors will move the laser head(s) to the coordinate system origin in the back right corner of the working area. The head should move quickly at first, then more slowly as the origin is determined accurately. (In subsequent use, the laser head will then move rapidly to its previously set origin position from last time the machine was used.)

4. Place a test piece under the laser head

Place a suitable piece of thin scrap material (paper, cardboard, thin acrylic, etc) in the center of the working area. Confirm that the laser head will clear the thickness of your

test material. Then use the arrow buttons on the control panel to move the laser head over the test material. The head will move rapidly in the direction of whatever arrow button you press.

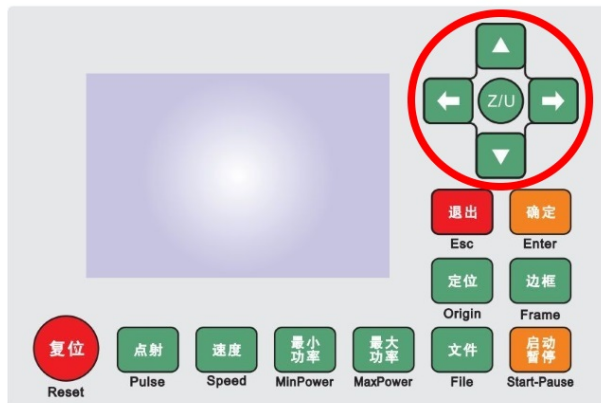

5. Switch on water chiller and exhaust blower

If you have not already done so, plug in and power on the water chiller unit and the exhaust blower. Never activate laser power without both of these units operating!

6. Enable laser power

After closing all doors, drawers, and ports on the machine, including the main lid, push the green laser power button above the control panel: It will light up indicating that the laser is enabled and ready to fire. (On dual laser machines, you can activate one or both tubes, just make sure there is test material under whichever laser heads(s) you choose to activate. Laser 1 powers the head on the left.)



This button only enables laser operation. It does not actually switch on the laser until the rest of the control system is calling for laser power.

7. Test the laser tube

Press the Pulse button on the control panel to briefly activate laser power. You should see a burned spot, or a small hole, appear instantly underneath the laser head. (Look carefully: in some materials the hole may be almost invisible.) You can alternate use of the arrow buttons and the Pulse button to punch multiple holes in your test piece, and test that the laser is firing reliably.

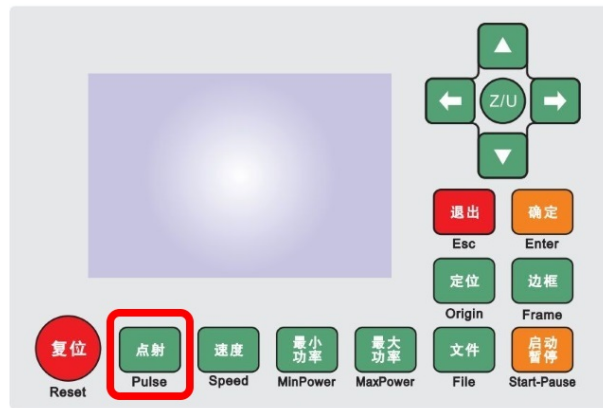

Congratulations, you now have a fully operational laser cutting and engraving system!

(Or if not, please see the Troubleshooting Guide.)



CAUTION:

Once you have pushed the Pulse button, or in any other way energized the laser tube, there is the potential for residual high voltage to be present on the anode (red) wire in the laser enclosure. Do not touch this wire without first reading the discharging instructions in the troubleshooting guide.

Calibrate Laser Route

Now we'll guide you to calibrate laser route to get the machine ready to use. Adjust laser tube, 1st, 2nd and 3rd mirror in order, make sure laser beam is shooting at the center of all mirrors and emitting out of nozzle of laser head at center. Then check if the focus lens are installed in right position by trigger laser pulse and check the burned dot, it should be very tiny. To avoid overburning, we recommend to set min power to 6% and max power to 8% as described in last section.

Following figures describe methods and steps to calibrate laser route briefly. please refer to [Calibrate Laser Route](#) on page 35 to get more details.

1st mirror adjust method

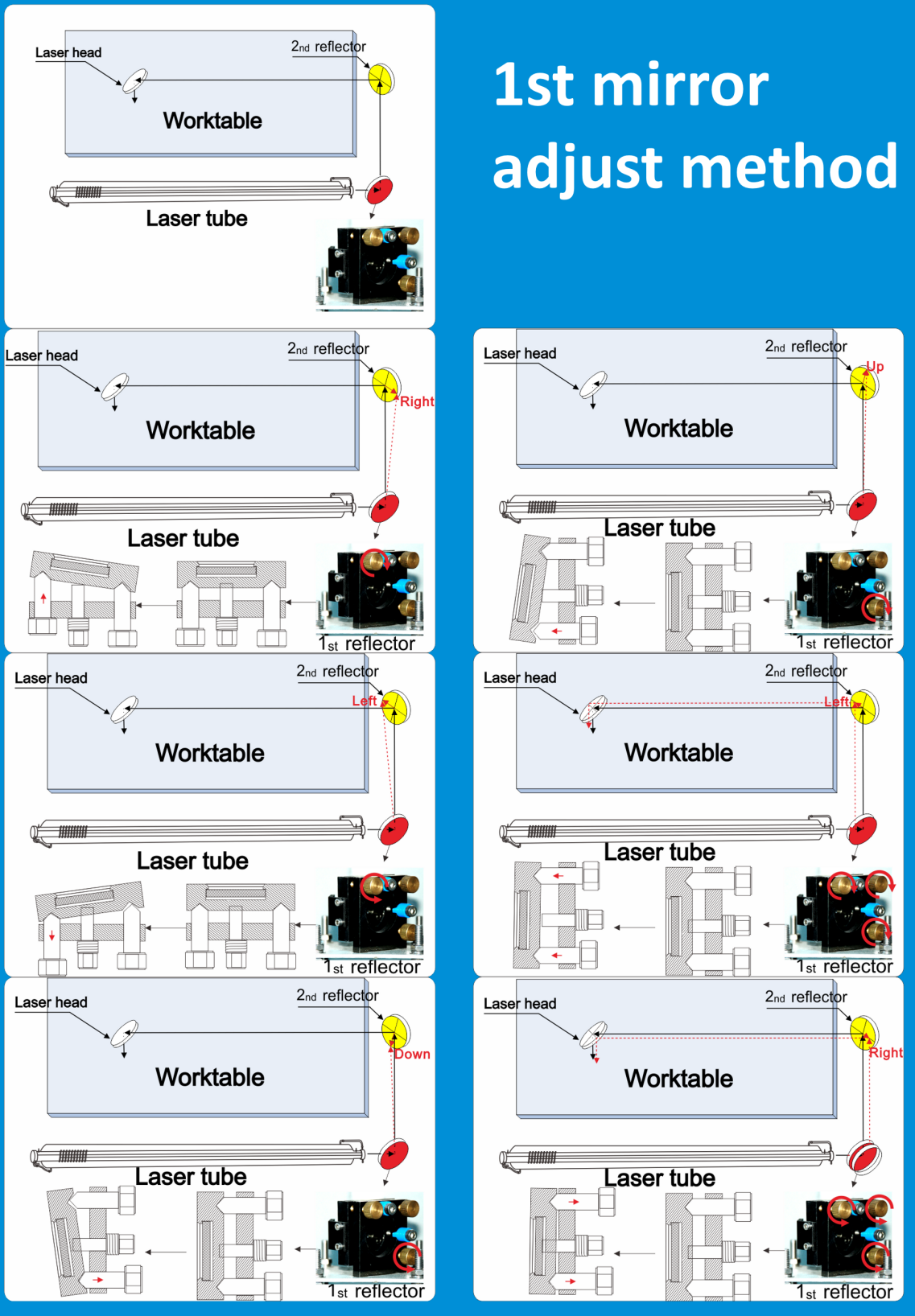

Figure 2-3: 1st mirror adjust method

2nd mirror adjust method



Figure 2-4: 2nd mirror adjust method

3rd mirror adjust method

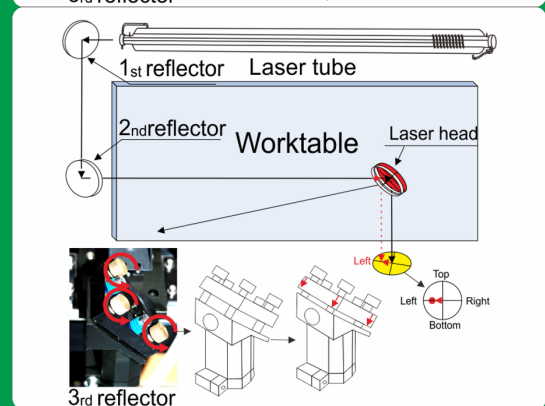
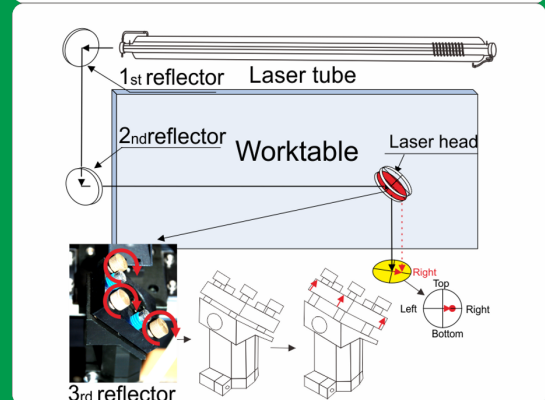
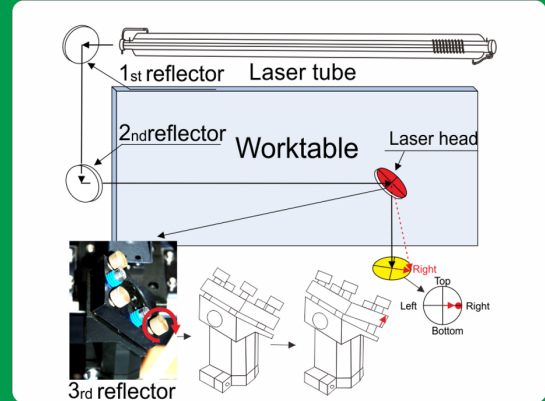
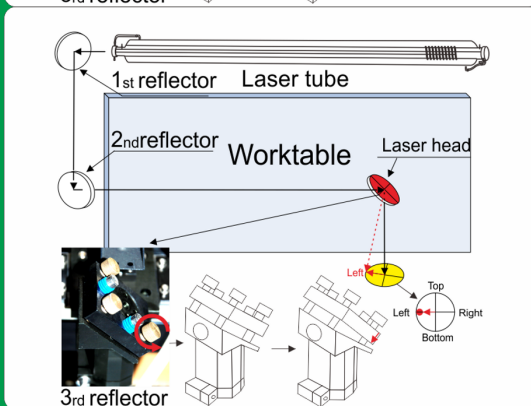
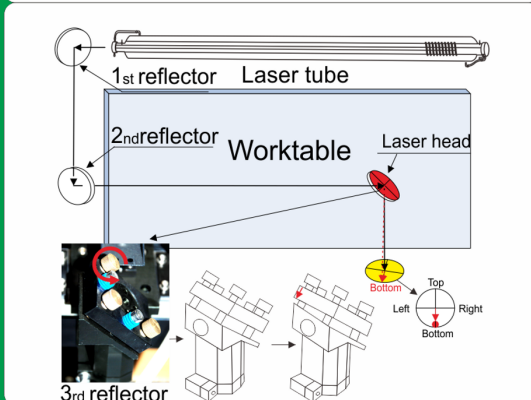
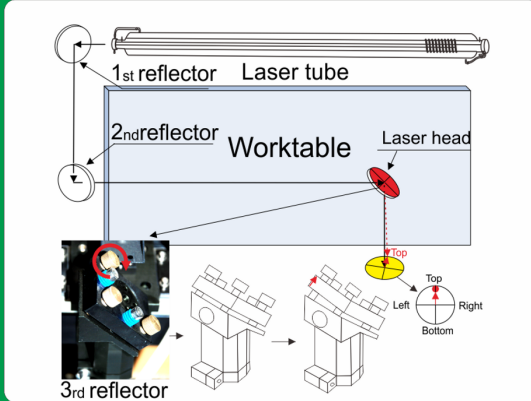
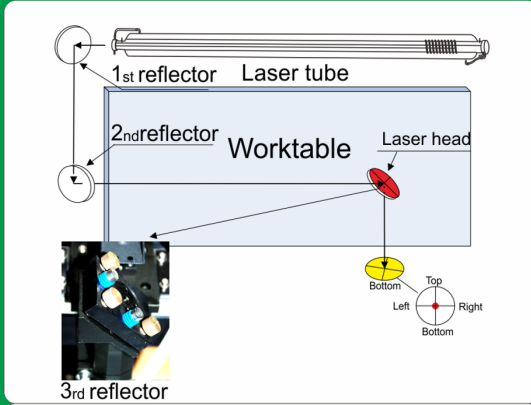

Figure 2-5: 3rd mirror adjust method



Calibration steps

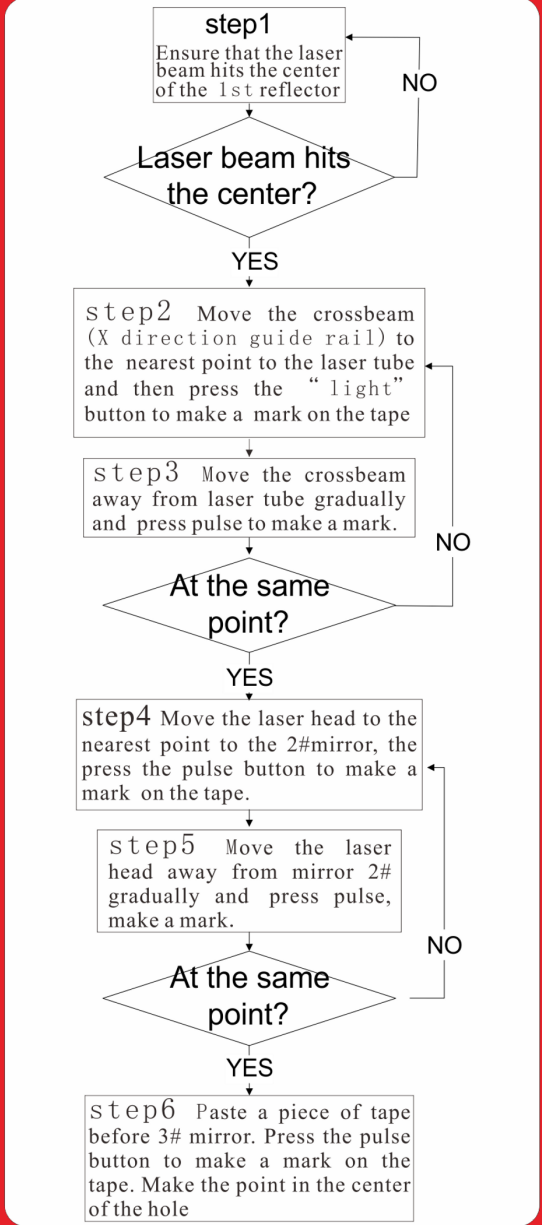
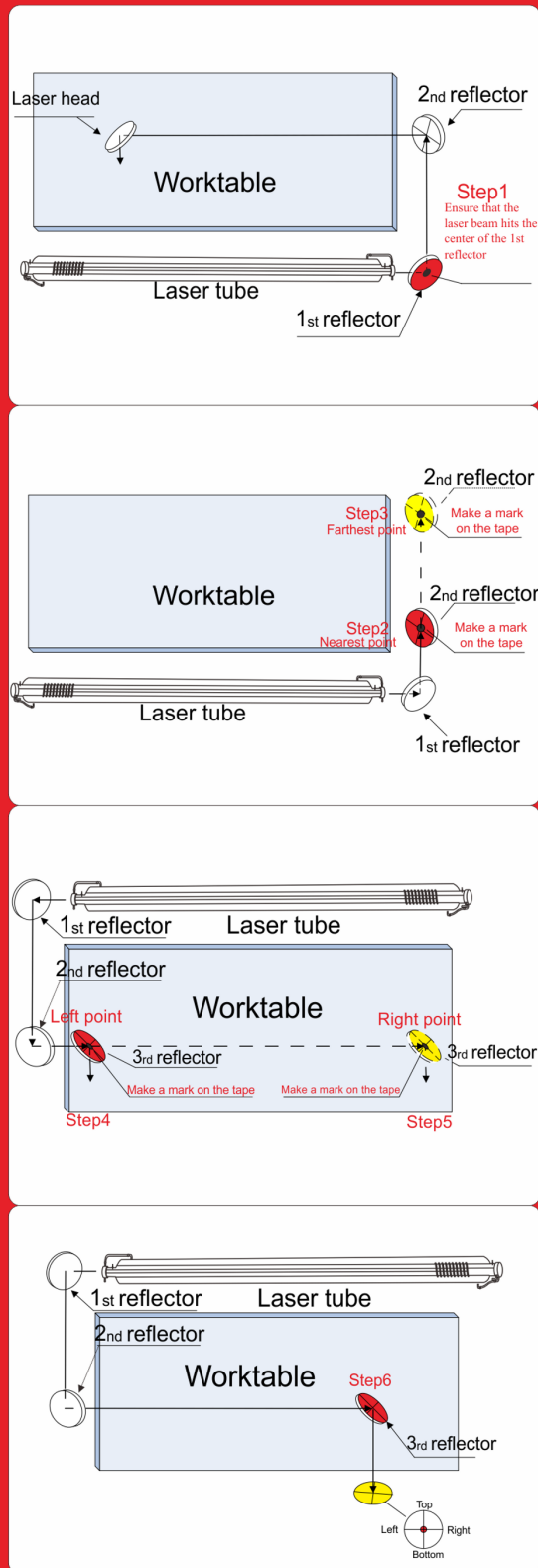
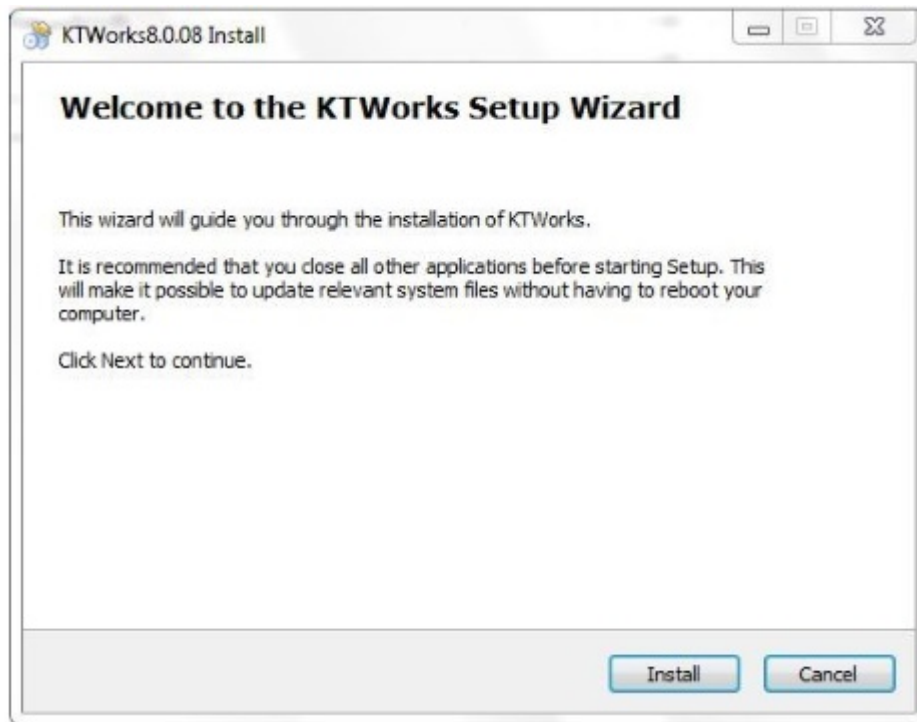

Figure 2-6: Laser route calibration steps

Install Software

Insert CD of software package into computer and double click setup file named **EagleWorksSetup_x.xx.xx.exe**, you will see dialog as shown below.



Click **Install** button, you will see option dialog as shown below.



1. Click **Install USB driver** button to install communication driver for control system.
2. Choose **Language** and set **Type** to **RDWorks**.
3. Click **Install** button to install EagleWorks software to your computer.

After software installation finished, click **Exit** button to close the dialog, then you can find **EagleWorks** directory in Windows start menu.

Create And Send A Job To Machine

Follow steps below to create and send a job to the machine.

1. Start software by click **Start > EagleWorks > EagleWorks**, you will see window shown as below.

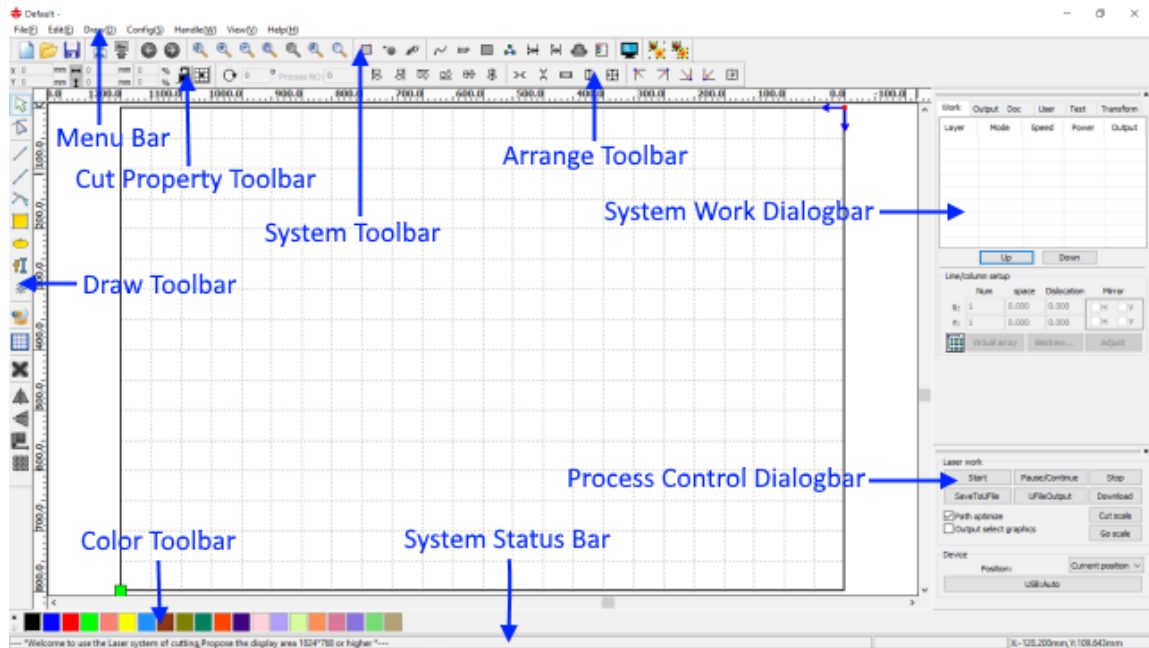

You need to get familiar with basic elements of the user interface. You can use drawing tools in **Draw Toolbar** to draw some graphic objects, modify graphics using **Cut Property Toolbar**, align or place graphics using **Arrange Toolbar**, set processing parameters using **System Work Dialogbar**, and send job to machine using **Process Control Dialogbar**. Please refer to [#unique_15](#) for more details.

2. Use **Ellipse** tool to draw a circle with diameter of 30mm, shown as below.

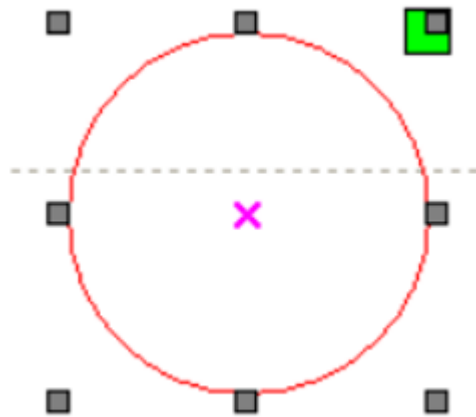
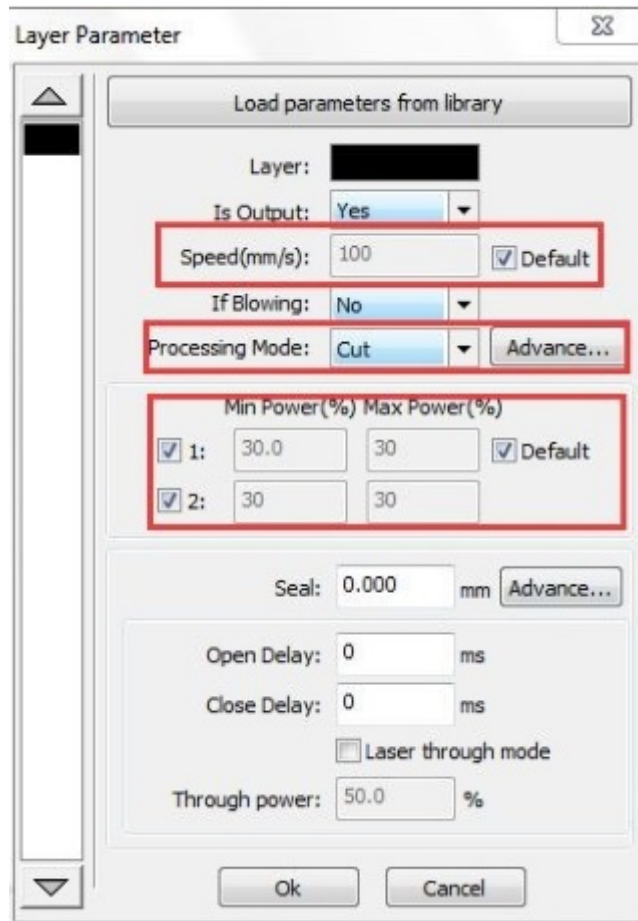

Figure 2-7: Draw a circle in KTWorX software

3. Set processing parameters.

Double click layer in **System Work Dialogbar**, **Layer Parameter** dialog will be shown as below. Check **Default** option for **Speed**, set **Processing Mode** to **Cut**, and check **Default** option for **Min Power** and **Max Power**, then click **OK** button to save settings.



4. Connect to machine by USB cable provided in software package, see [#unique_16/unique_16_Connect_42_frontlayout](#) for more details.
5. Send job to the machine.

Check **Path optimize** option in **Process Control Dialogbar**, then click **Download** button to send job to the machine, shown as below.

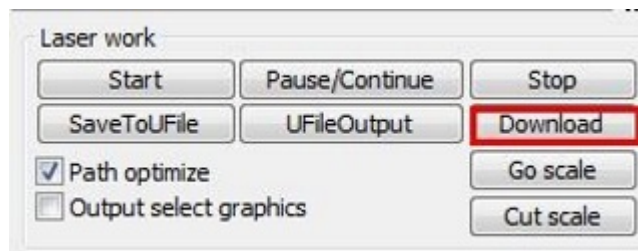

Make A Sample

Follow steps below to make a sample.



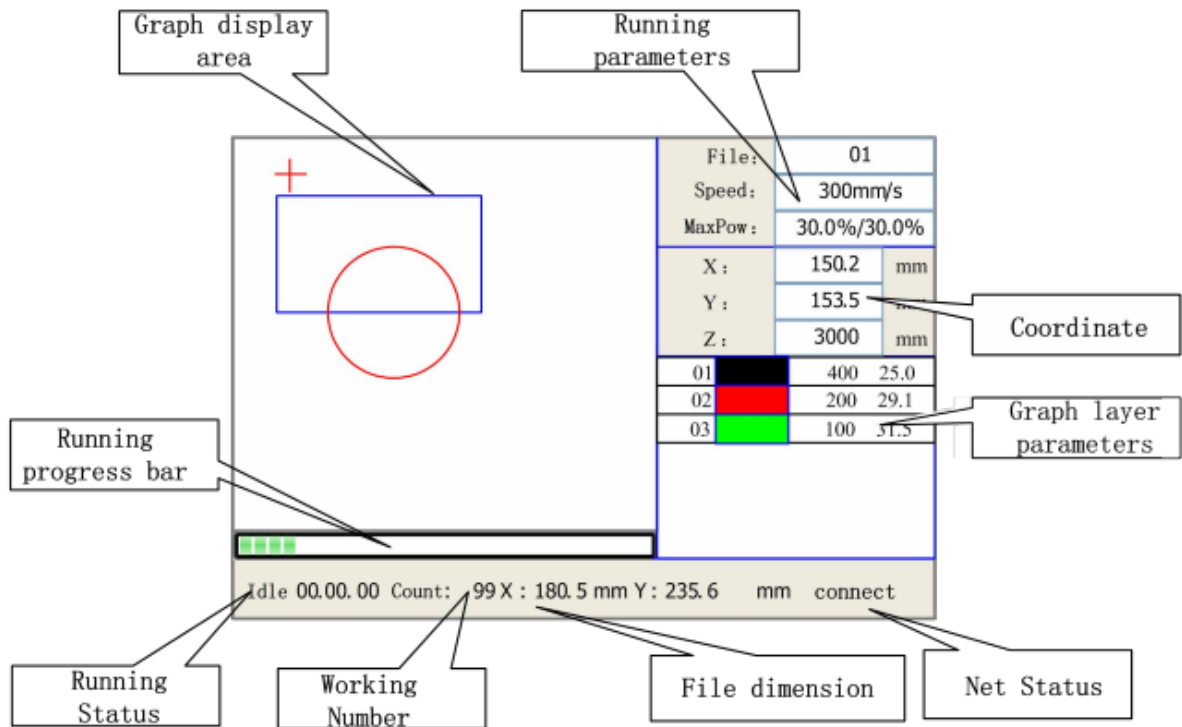

1. Choose a job

Press **File** button on control panel to enter file list interface, shown as below.

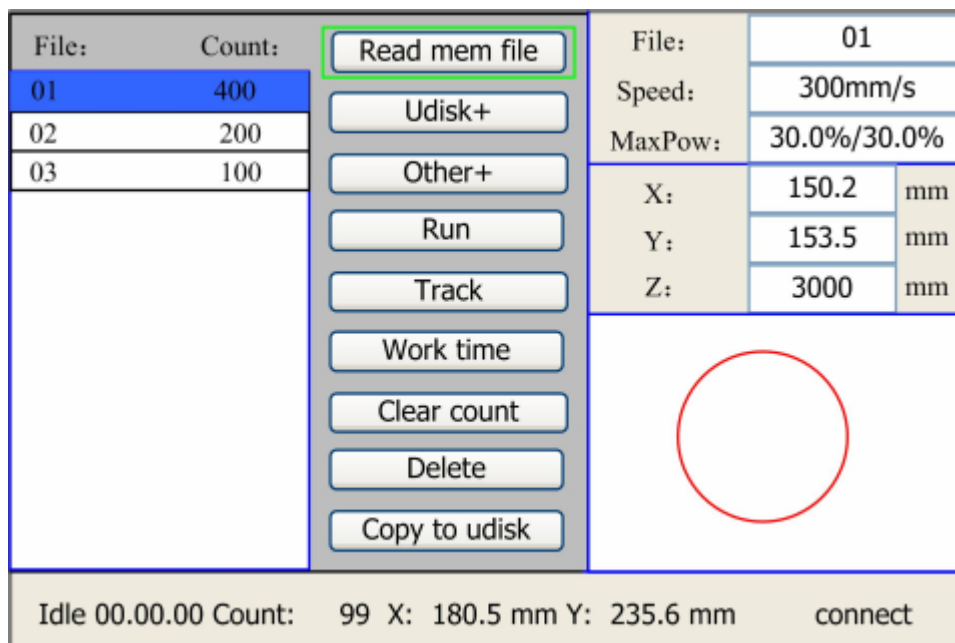

Use **Up/Down** button to choose the file you sent to machine just now, then press **Enter** button to confirm selection.

2. Set processing parameters

Press **Enter** button to open processing parameters setting interface for current layer, shown as below.

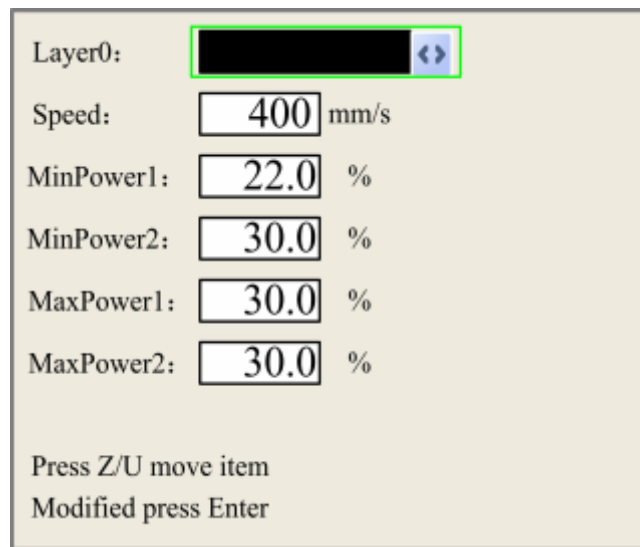

Press **Up/Down** button to select **Speed** option, press **Enter** button and change the value to 10mm/s (for cutting 8mm acrylic). Then select **MinPower** and **MaxPower** option and change the value to 98%.

Note: Settings above is for cutting 8mm acrylic, please refer to to get recommend settings for other kinds of material.

3. Set relative origin

Move laser head to a proper position above the material and press **Origin** button to set it as the relative origin, which is corresponding to the green point mark shown in [Figure 2-7: Draw a circle in KTWworks software](#) on page 30.

4. Check processing range

Press **Frame** button, control system will move laser head to draw a bounding frame to indicate processing range.



Attention: If bounding frame of the job according to the relative origin is out of working area limit, control system will show you a error message, please change position of the relative origin.

5. Correct focal length

Use focuc checking block provided in software package to check if the focal length is set correctly, as shown below.



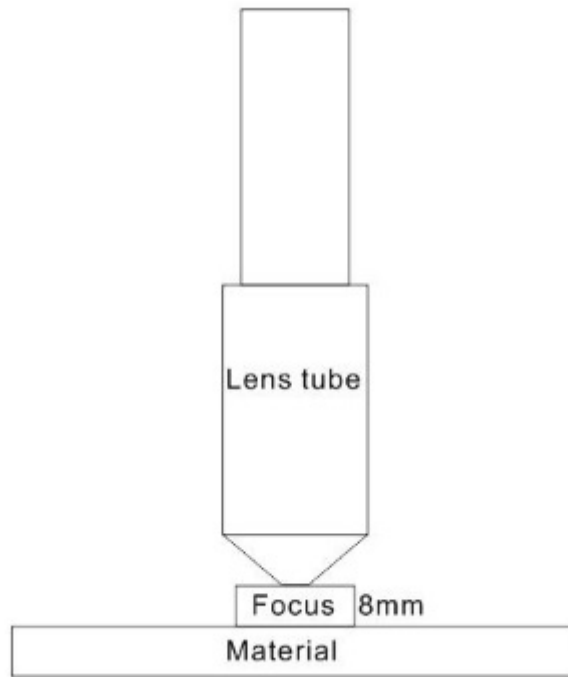

If not, release fixing screw of lens tube on laser head, move it upward or downward to correct focal length.

6. Start processing

Close front door, switch on exhaust blower, press **Start/Pause** button to start processing.



Attention: If anything wrong, please press **Start/Pause** button to pause processing or press **Emergency** button IMMEDIATELY to shutdown the machine!



Attention: When cutting acrylic, especially thick one, material may catch fire, please press **Start/Pause** button to pause processing and wait for flameout.

Chapter

3

Calibrate Laser Route

Topics:

- [Preparation](#)
- [Calibrate Laser Route to 1st Mirror](#)
- [Calibrate Laser Route to 2nd Mirror](#)
- [Calibrate Laser Route to 3rd Mirror](#)
- [Check Laser Route](#)
- [Calibrate Laser Route To Workpiece](#)

Correctly aligned laser route is one of the most important factor which highly impact performance and processing quality of laser machine.

When you replace a new laser tube, or reflection mirror base, or some parts of laser head, you need to calibrate laser route. Sometimes, you need to it after accident collisions, mirror adjust screw loose, or something unexpected happened.

This chapter show you detail information on adjust methods and steps for calibrating laser route.



Preparation

Prior to start calibrating laser routing, you should be familiar to install laser tube, connect chiller, and basic operations of the machine. If not, please refer to [#unique_19](#) to get to know the machine.

Then, please refer to [#unique_20](#) to get a brief but clear picture of whole process, and relevant settings we suggested to use.

Calibrate Laser Route to 1st Mirror

1. Adjust 1st mirror to make laser beam shoot center of it's aligning plate.

Stick a piece of tape on aligning plate, press **Pulse** button to shoot on it, shown as below.

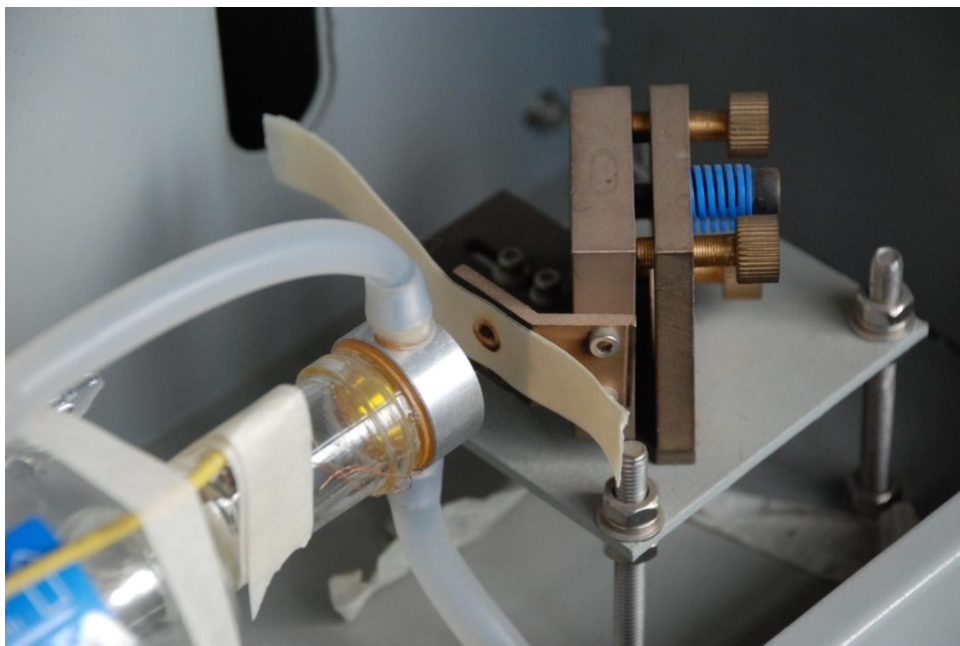

Burnt spot by laser should be at center of circle of aligning plate. If not, you should adjust base support screws to move mirror upward or downward, or adjust base fixing screws to move mirror left or right, then check again, and do more adjustment if needed, until it's calibrated.

2. Adjust 1st mirror to make laser beam shoot through the hole on box.

Stick a piece of tape on box, press **Pulse** button to shoot on it, shown as below.



Burnt spot should be in range of the hole. If not, you should adjust base fixing screws to move mirror left or right, then check again, and do more adjustment if needed, until it's calibrated.

Calibrate Laser Route to 2nd Mirror

Follow steps below to calibrate laser route from 1st mirror to 2nd mirror.

1. Adjust method

Before start to calibrate, you should get to know basic law of adjust method. You need to meet two requirements at the same time, shown as below.

- a. Adjust angle of 1st mirror to align laser route parallel to moving direction of 2nd mirror.
- b. Make laser beam shoot at center of 1st and 2nd mirror at the same time.

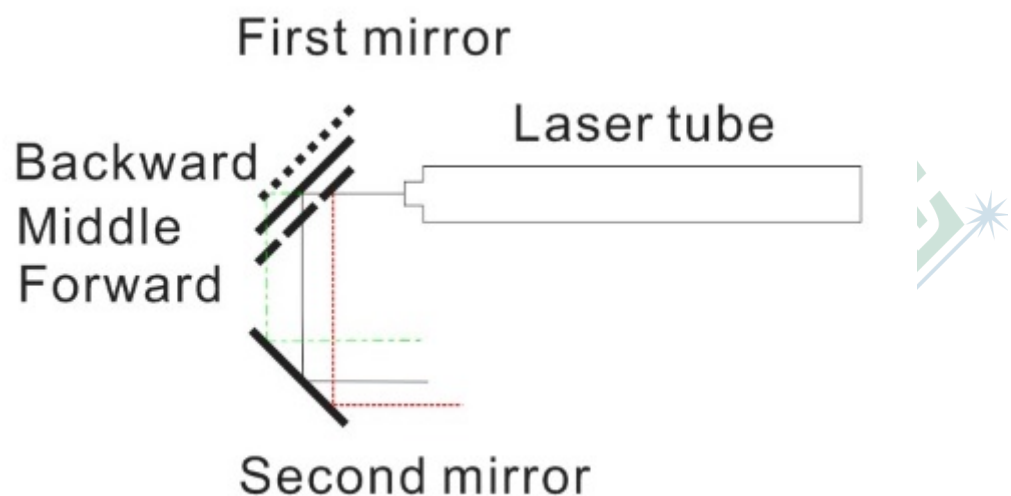
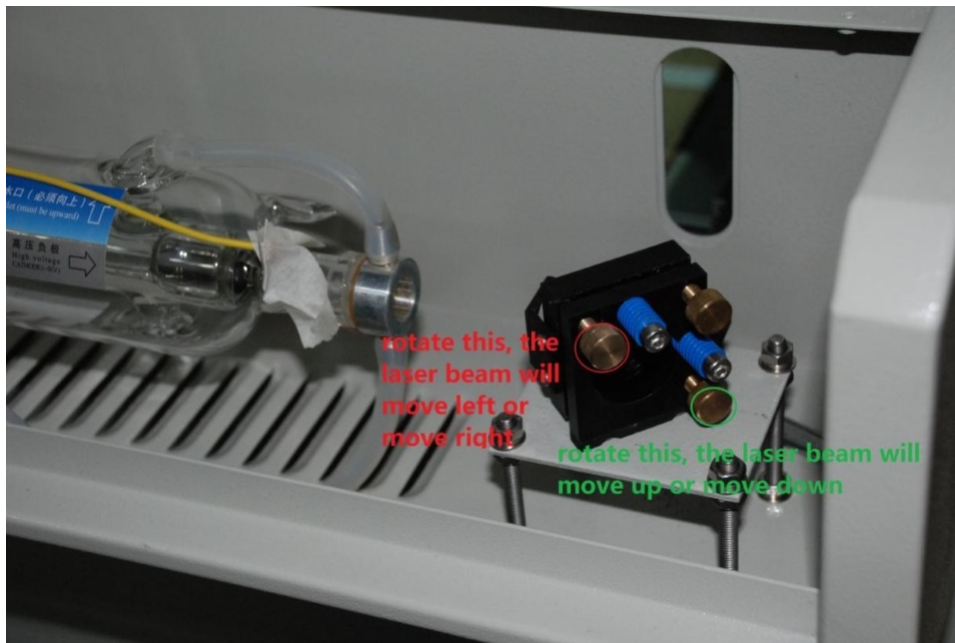

Figure 3-8: Basic law of adjust method of calibrating laser route to 2nd mirror

There are 3 mirror adjusting screws on back of mirror base, shown as below. Screw on top corner (in red circle) is for adjusting angle according to vertical axis of mirror, turning laser beam left or right, screw on bottom corner (in green circle) is for adjusting angle according to horizontal axis of mirror, turning laser beam up or down, screw in center is used as a fulcrum.

If you want to move mirror forward or backward a little, adjust 3 screws at the same time and the same scale.



Sometimes, you cannot meet the two requirements at the same time by adjusting mirror adjusting screws only, you need to adjust mirror base, an extra help, to achieve the goal, shown as below.

Move mirror base forward, laser beam will move right, move mirror base backward, laser beam will move left, see [Figure 3-8: Basic law of adjust method of calibrating laser route to 2nd mirror](#) on page 37 for more details.

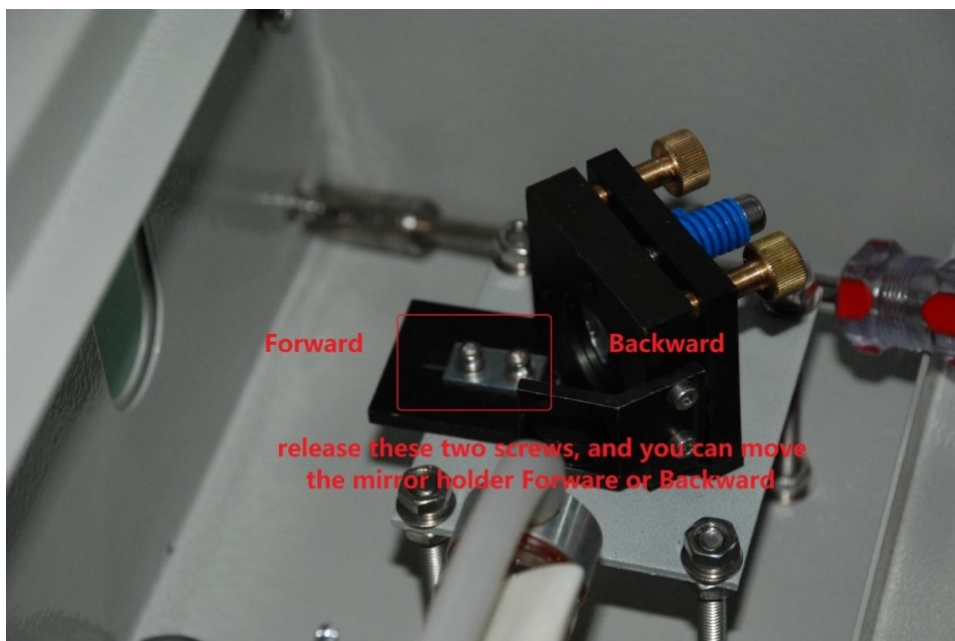



Attention: After you move mirror base, angle of mirror may be changed a little, so you should adjust mirror angle again!

2. Check current laser route

Stick a piece of tape on aligning plate of 2nd mirror, press **Up** direction button to move X axis to top of working area, press **Pulse** button to shoot on it, shown as below.

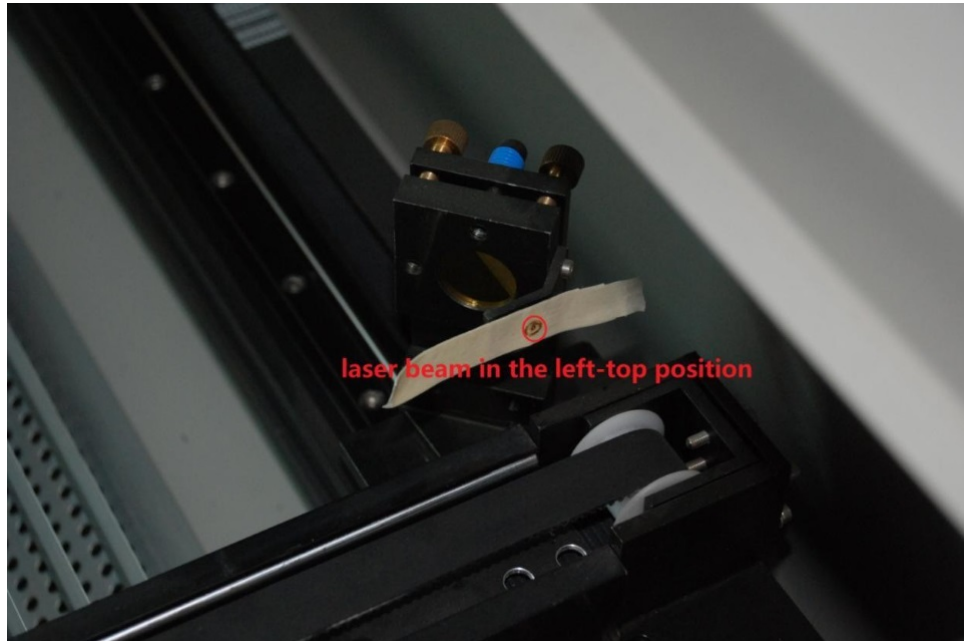

Check if burnt spot is at about center of circle of aligning plate. If it's a little far from center, please do some adjustment until it's aligned.

Then press **Down** direction button to move X axis to bottom of working area, press **Pulse** button to shoot on the same tape, shown as below.

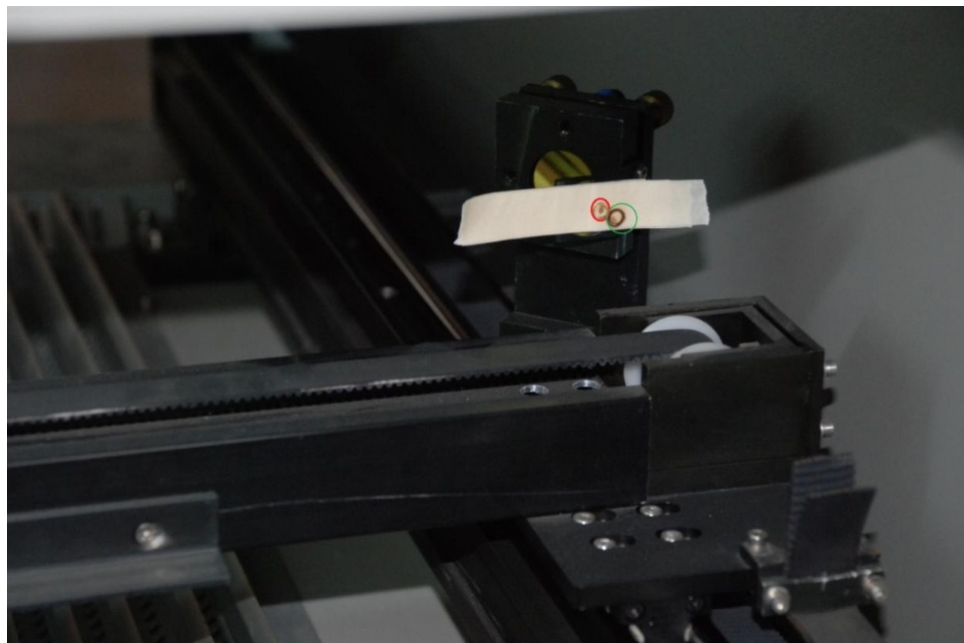

Check if two burnt spots are at same position and at about center of aligning plate. If not, follow steps below to calibrate laser route.

Tip: Sometimes, there is no second burnt spot on the tape, that's because laser route is deflected too much and the shot position is out of the tape. You can press **Up** direction button to move X axis to nearer position to 1st mirror and make a shot, if you get second burnt spot, you can follow steps below to calibrate laser route here, then make a confirmation at the bottom position later.

3. Calibrate laser route

In this sample, two burnt spots are not at same position, the second one (green) is at bottom right of the first one (red), we should turn laser beam a little up and a little left.

Rotate the bottom corner adjusting screw clockwise to turn laser beam up, and rotate the top corner adjusting screw counter clockwise to turn laser beam left, then press **Pulse** button to shoot on the tape, shown as below.



The new burnt spot is at top left of the first one, we should adjust a little back on both directions.

4. Check calibrated laser route

Stick a new piece of tape on aligning plate and move X axis to top of working area, press **Pulse** button to shoot on it, shown as below.

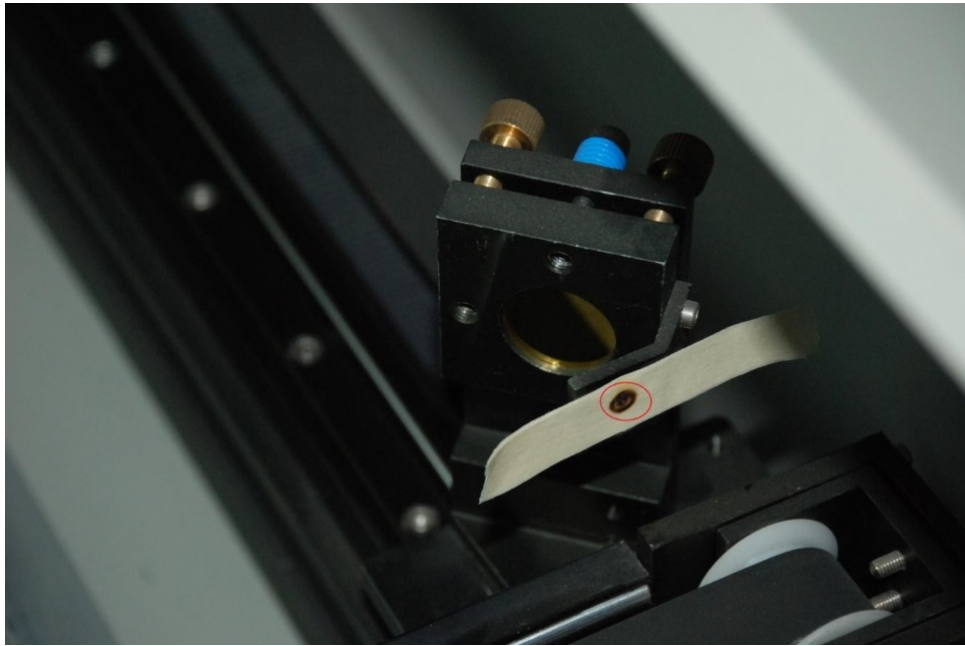

Then move X axis to bottom of working area, press **Pulse** button to shoot on it, shown as below.

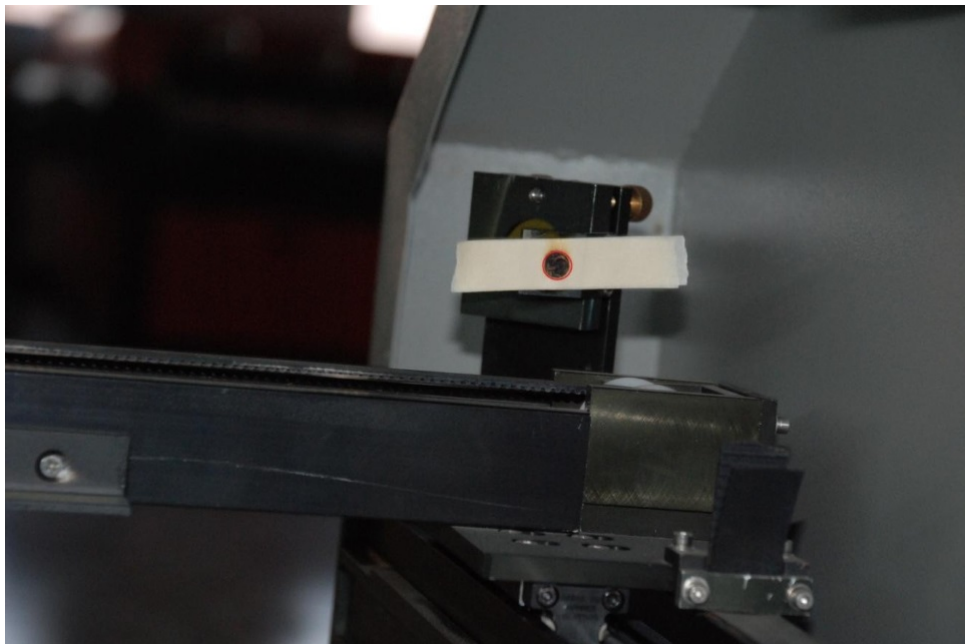

Check if two burnt spots are at same position and at center of circle of aligning plate at the same time. If not, repeat steps above until it's calibrated.



Attention: After checking and confirming laser route to 2nd mirror is aligned, please tighten two screws with spring on 1st mirror's base to stabilize laser route.

Calibrate Laser Route to 3rd Mirror

Follow steps below to calibrate laser route from 2nd mirror to 3rd mirror.

1. Adjust method

The basic law is very similar to the one for adjust method of calibrating laser route to 2nd mirror, you need to meet two requirements at the same time, shown as below.

- a. Adjust angle of 2nd mirror to align laser route parallel to moving direction of 3rd mirror.
- b. Make laser beam shoot at center of 2nd and 3rd mirror at the same time.

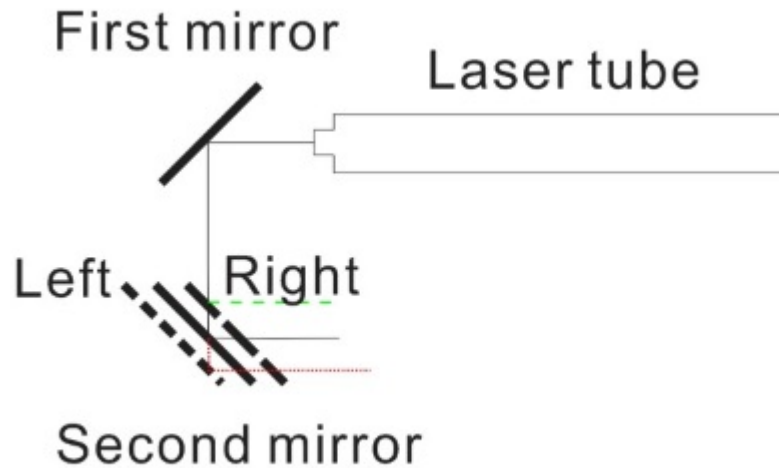
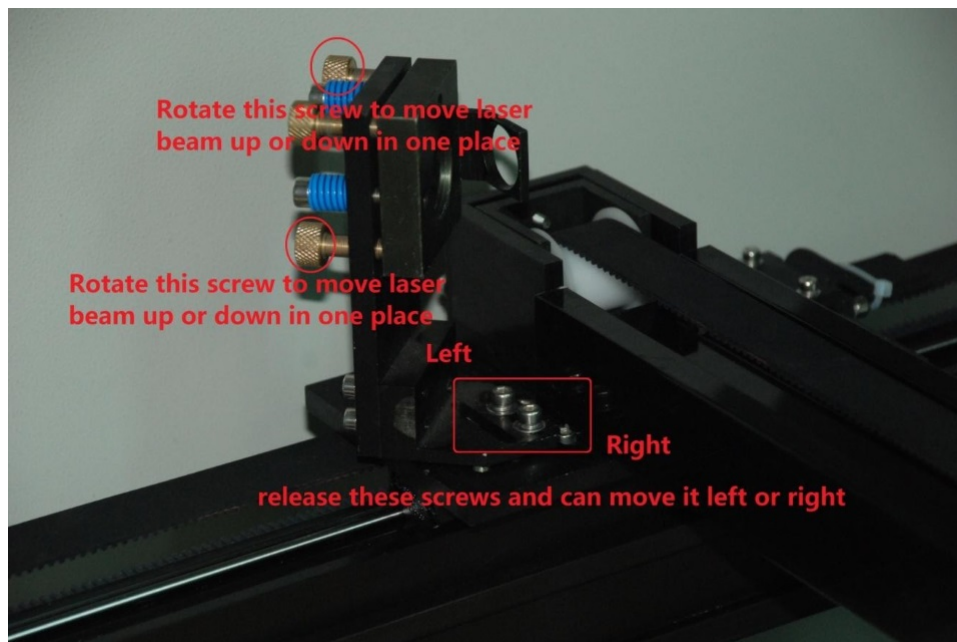

Figure 3-9: Basic law of adjust method of calibrating laser route to 3rd mirror

Adjust method is exactly same with the one for calibrating laser route to 2nd mirror, shown as below.



Move mirror base left, laser beam will move outer, move mirror base right, laser beam will move inner, see [Figure 3-9: Basic law of adjust method of calibrating laser route to 3rd mirror](#) on page 42 for more details.

2. Check current laser route

Stick a piece of tape on aligning plate of 3rd mirror, press **Left** direction button to move laser head to left of working area, press **Pulse** button to shoot on it, shown as below.

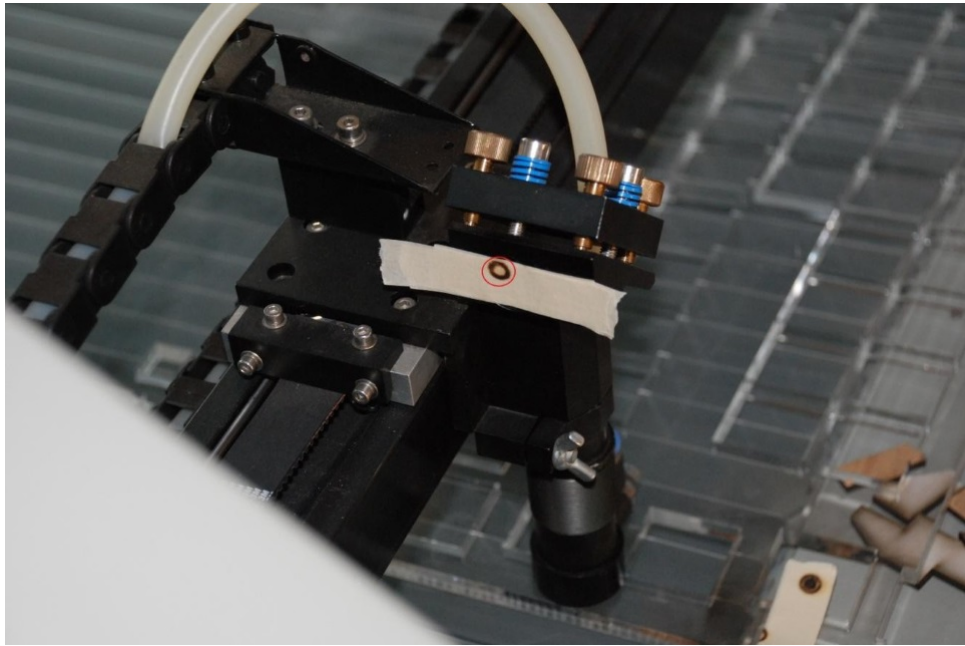

Check if burnt spot is at about center of circle of aligning plate. If it's a little far from center, please do some adjustment until it's aligned.

Then press **Right** direction button to move laser head to right of working area, press **Pulse** button to shoot on the same tape, shown as below.

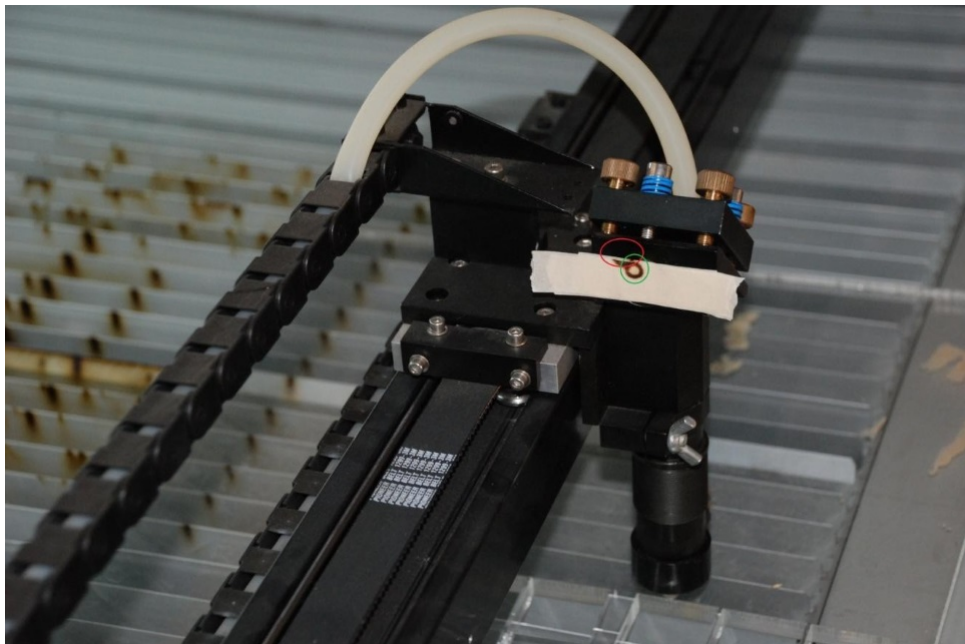

Check if two burnt spots are at same position and at about center of aligning plate. If not, follow steps below to calibrate laser route.

3. Calibrate laser route

In this sample, two burnt spots are not at same position, the second one (red) is at top left of the first one (green), we should turn laser a little down and a little right.

Rotate the bottom corner adjusting screw counter clockwise to turn laser beam down, and rotate the top corner adjusting screw clockwise to turn laser beam right, then press **Pulse** button to shoot on the tape, shown as below.

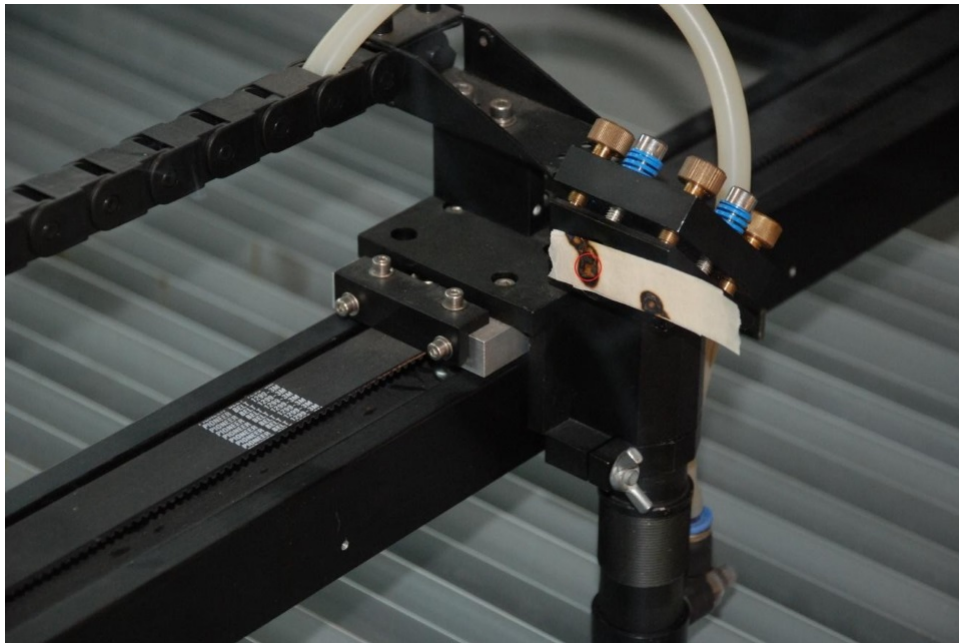
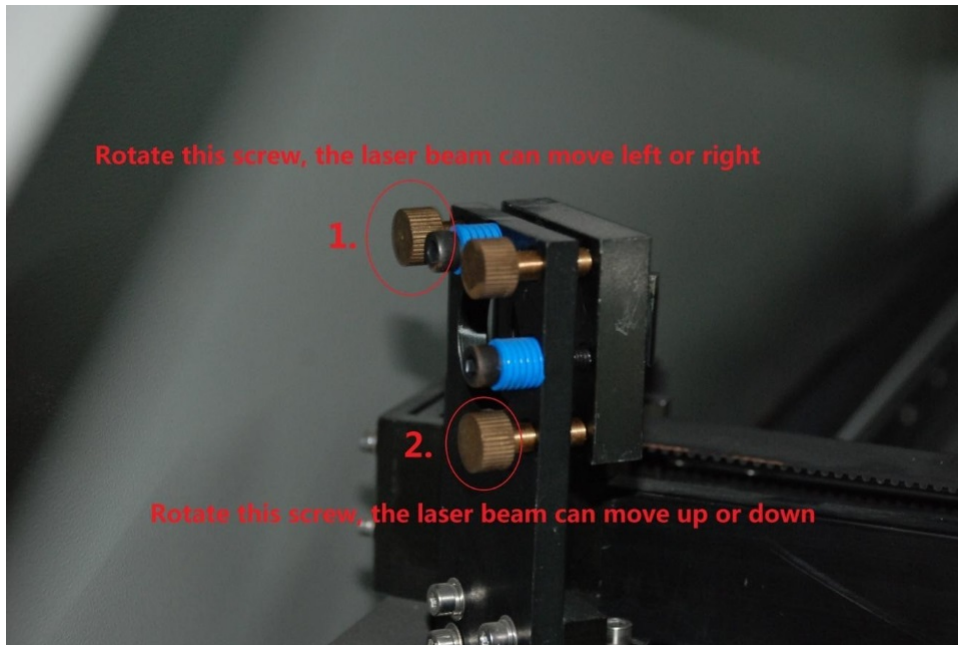

After several times of adjustment, we got burnt spots aligned.

4. Check calibrated laser route

Stick a new piece of tape on aligning plate and move laser head to left of working area, press **Pulse** button to shoot on it, shown as below.

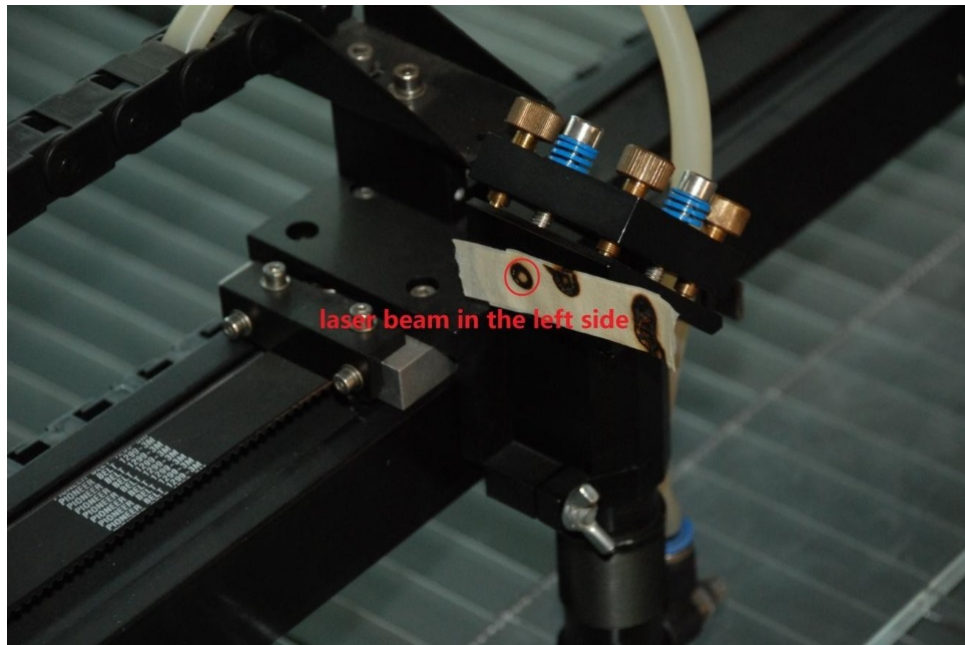

Then move laser head to right of working area, press **Pulse** button to shoot on it, shown as below.

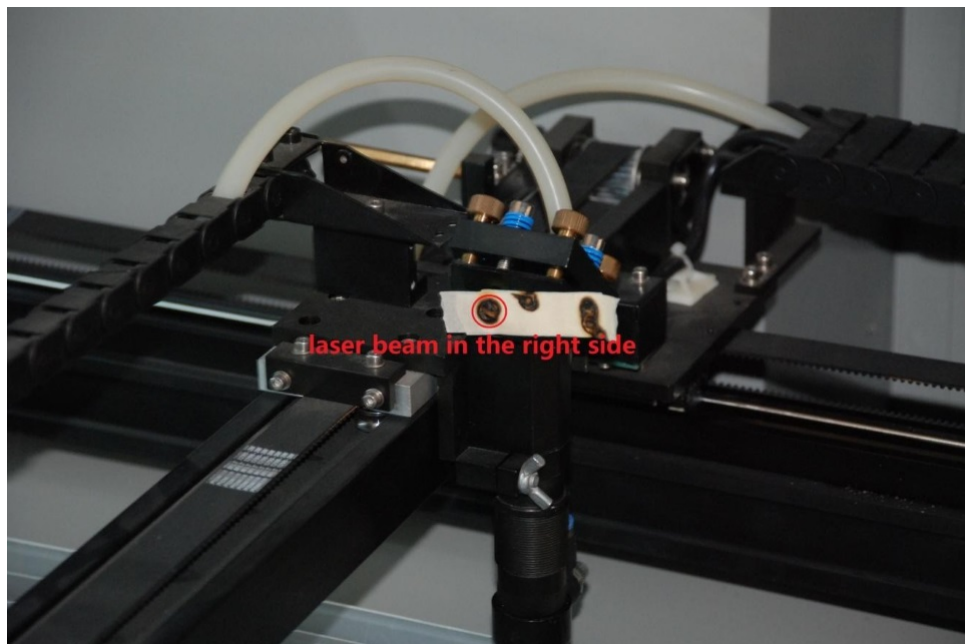

Check if two burnt spots are at same position and at center of circle of aligning plate at the same time, If not, repeat steps above until it's calibrated.



Attention: After checking and confirming laser route to 3rd mirror is aligned, please tighten two screws with spring on 2nd mirror's base to stabilize laser route.

Check Laser Route

After calibrate laser route to all 3 mirrors, please double check laser beam alignment at four corner of working area by following steps below.

1. Stick a piece of tape on aligning plate of 3rd mirror, move laser head to top left corner of working area, press **Pulse** button to shoot on it, shown as below.



2. Move laser head to top right corner of working area, press **Pulse** button to shoot on the tape, shown as below.

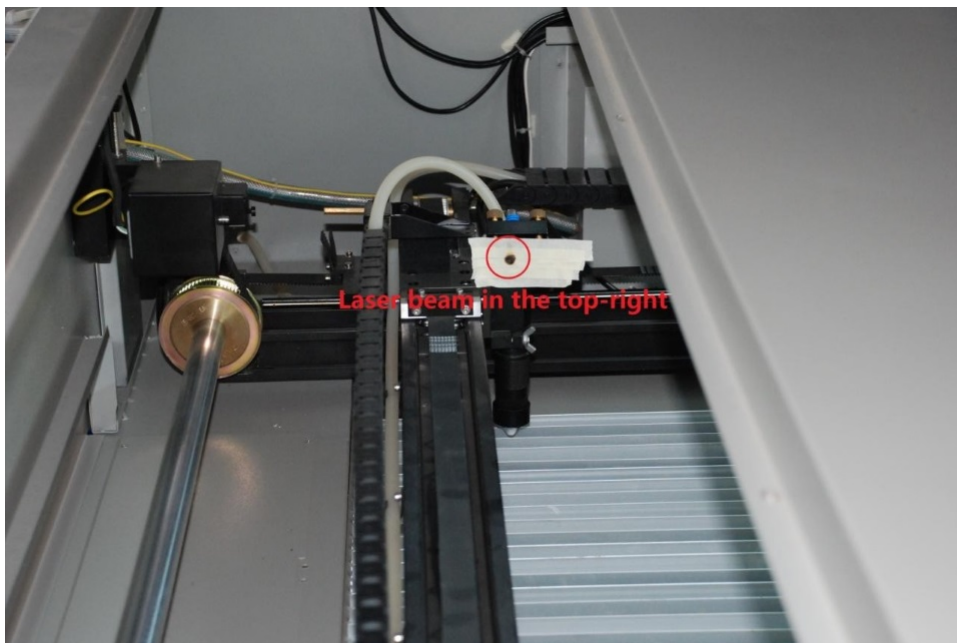

3. Move laser head to bottom right corner of working area, press **Pulse** button to shoot on the tape, shown as below.



4. Move laser head to bottom left corner of working area, press Pulse button to shoot on the tape, shown as below.

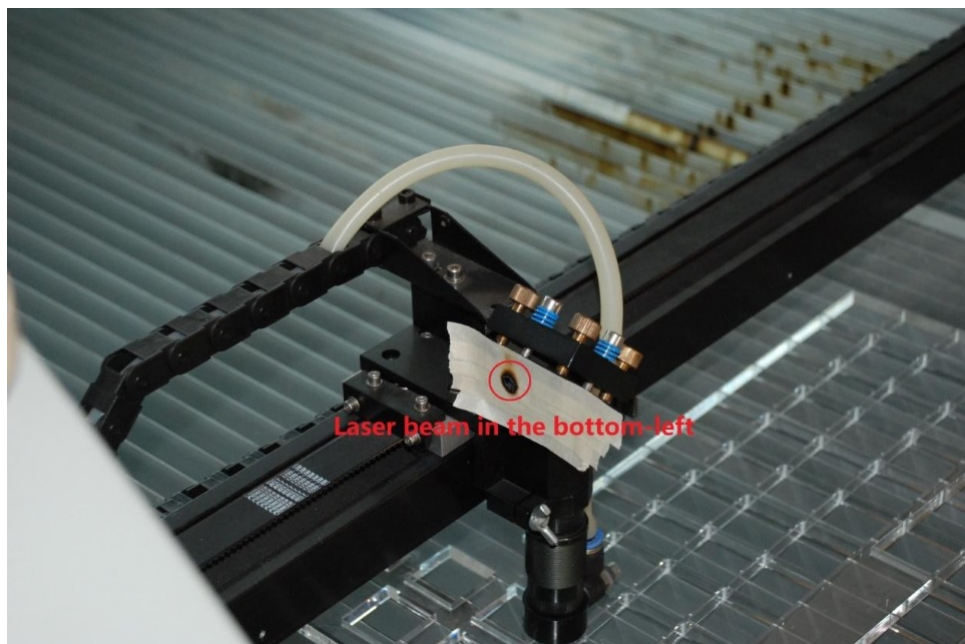

Check if four burnt spots are at same position and at center of circle of aligning plate at the same time. If not, check and calibrate laser route to all 3 mirrors again.

Calibrate Laser Route To Workpiece

Follow steps below to calibrate laser route from 3rd mirror to workpiece.

1. Adjust method

The basic law is a little different to the one for adjust method of calibrating laser route to 2nd and 3rd mirror, you need to meet two requirements below at the same time.

- a. Adjust angle of 3rd mirror to make laser beam go through center of nozzle of laser head.
- b. Laser beam is perpendicular to workpiece.

Mechanical structure of 3rd mirror is contrary to 1st and 2nd mirror, 3 mirror adjusting screws are mounted on mirror holder, not on base, shown as below. Screw on top corner (marked no.1) is for adjusting angle according to vertical axis of mirror, turning laser beam inner or outer, screw on bottom corner (marked no.2) is for adjusting angle according to horizontal axis of mirror, turning laser beam left or right, screw in center is used as a fulcrum.

If you want to move mirror forward or backward a little, adjust 3 screws at the same time and the same scale.

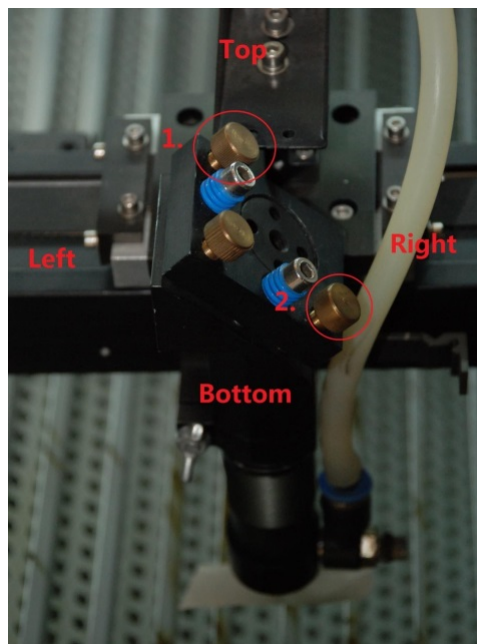

If laser beam go through center of nozzle of laser head, but is not perpendicular to workpiece, you should move mirror forward or backward to resolve the problem.

If laser beam is leaning from left to right, move mirror backward, if laser beam is leaning from right to left, move mirror forward, then adjust angle to make laser beam go through center of nozzle of laser head. Check again, and do more adjustment if needed, until it's calibrated.



Attention: Rotating direction of mirror adjusting screw is contrary to 1st and 2nd mirror due to it's mechanical structure.

2. Check and calibrate laser route

Stick a piece of tape on nozzle of laser head, press **Pulse** button to shoot on it, shown as below.



Check if burnt spot is at about center of nozzle. If not, do some adjustment until it's aligned.

Make a sample on 8mm acrylic to check if laser beam is perpendicular to workpiece. If not, do some adjustments until it's calibrated.

Chapter 4

Control Panel

Topics:

- [Introduction](#)
- [Main Interface](#)
- [File Interface](#)
- [Settings](#)
- [Alarm](#)

This chapter will show you details about panel for control system.



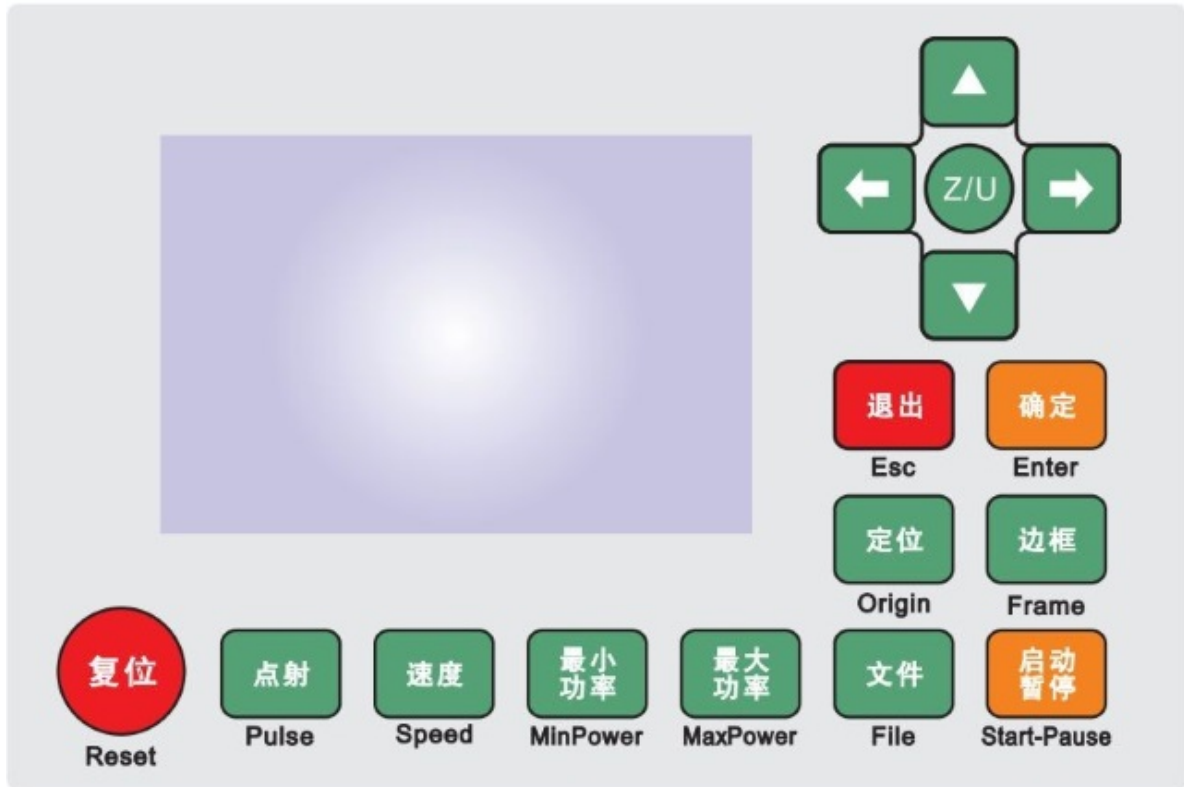

Figure 4-10: Layout of control panel

Table 4-1: Action keys list

Key	Function
Reset	Reset control system.
Pulse	Make a shot.
Speed	Set speed of layer of current job, or speed of direction keys.
MinPower	Set min laser power of layer of current job, or min laser power of Pulse key.
MaxPower	Set max laser power of layer of current job, or max laser power of Pulse key.
File	File management.
Origin	Set relative origin.
Frame	Trace bounding frame of current job.

Key	Function
Start/Pause	Start or pause current job.
Esc	Cancel current job, or exit to parent menu.
Enter	Confirm changes, or enter submenu.
Left/Right	Move laser head left or right, or move cursor left or right.
Up/Down	Move laser head left or right, or move cursor left or right.
Z/U	Enter settings menu.

Main Interface

After system is powered on, you can see main interface shown as below.

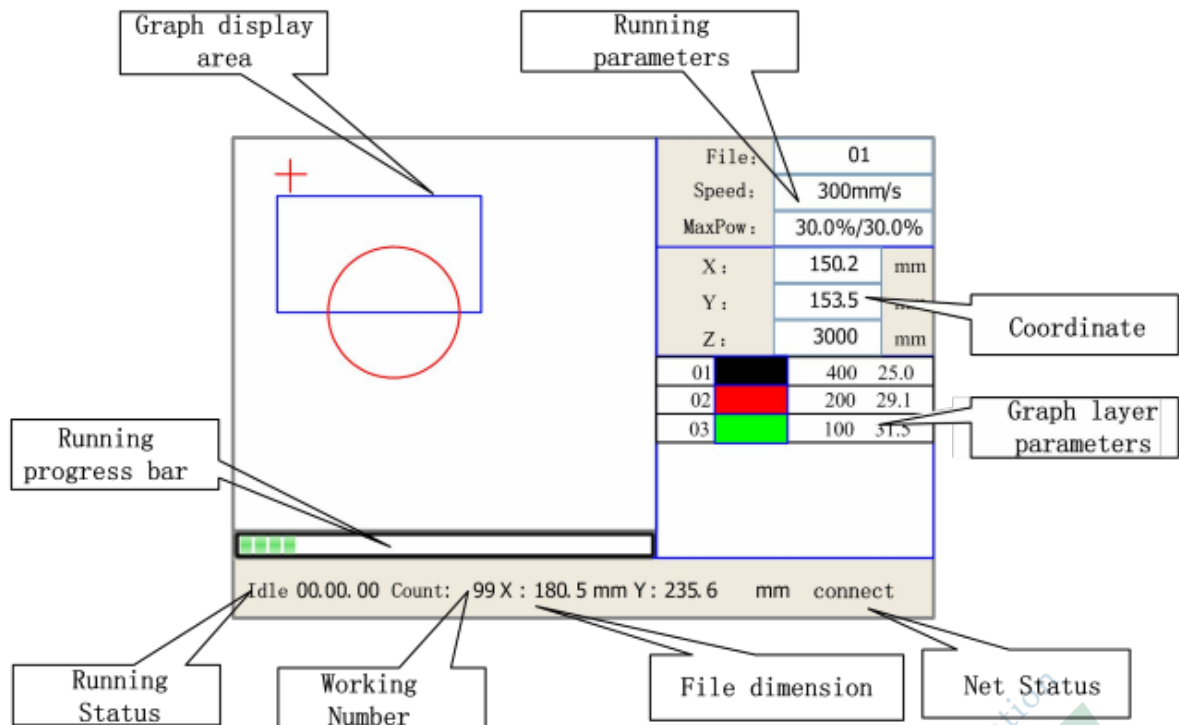

Figure 4-11: Layout of main interface

Section	Function
Graph Display Area	Show graphics of current job, and trace processing progress.
Running Parameters	Show parameters of current processing progress for current job or idle mode.
Coordinate	Show current coordinates or laser head.

Section	Function
Layer Parameters	Show layer parameters of current job, you can select and modify layer settings in idle mode.
Running Progress Bar	Show processing progress of current job.
Running Status	Show current processing status of control system.
Working Number	Number of processed pieces of current job.
File Dimension	Bounding frame dimension of current job.
Net status	Network connection status.

You can change settings in idle or paused mode by action keys, when system is in running mode, you need to pause or stop the current job, refer to [Table 4-1: Action keys list](#) on page 52 for more details.

1. Speed settings

Press **Speed** key to enter speed settings dialog, shown as below.

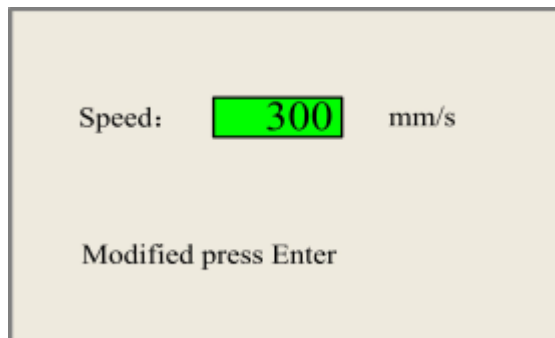

Press **Left** or **Right** keys to move cursor in numeral area, press **Up** or **Down** keys to change value, then press **Enter** key to confirm change, or press **Esc** key to cancel change.

2. Min/Max power settings

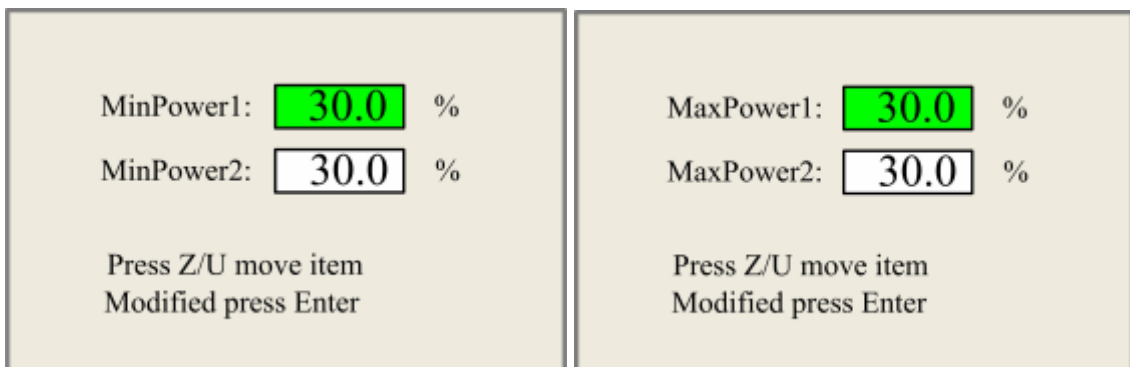

Press **MinPower** or **MaxPower** key to enter power settings dialog, shown as below.



Press **Z/U** key to switch between 1st and 2nd option, then use same method above to change values.

3. Layer settings of current job

After selecting a job to process, press **Enter** key to select 1st layer, press **Up** or **Down** key to select layer you want to modify, then press **Enter** key to enter layer settings dialog, shown as below.

01		400	25.1
02		200	29.1
03		100	31.5

Layer0:

Speed: mm/s

MinPower1: %

MinPower2: %

MaxPower1: %

MaxPower2: %

Press Z/U move item
Modified press Enter

Press **Z/U** key to switch between options, then use same method above to change values.

File Interface

In idle mode, press **File** key to enter file interface, shown as below.

File:	Count:	<input type="button" value="Read mem file"/>	File:	01	
01	400	<input type="button" value="Udisk+"/>	Speed:	300mm/s	
02	200	<input type="button" value="Other+"/>	MaxPow:	30.0%/30.0%	
03	100	<input type="button" value="Run"/>	X:	150.2	mm
		<input type="button" value="Track"/>	Y:	153.5	mm
		<input type="button" value="Work time"/>	Z:	3000	mm
		<input type="button" value="Clear count"/>			
		<input type="button" value="Delete"/>			
		<input type="button" value="Copy to udisk"/>			
Idle 00.00.00 Count: 99 X: 180.5 mm Y: 235.6 mm					

Figure 4-12: Layout of file interface

System will get list of files in memory first when enter in file interface, you can see the list in left column, press **Up** or **Down** key to move cursor, detail information of selected file will be shown in right column. After you found the file to process, press **Enter** key to confirm selection and return back to main interface.

There are function buttons in middle column, listed as below.

Button	Function
Read mem file	Get list of files in system memory.
Udisk+	Get list of files in flash memory.
Other+	Other operations you can do on memory files.
Run	Process selected job.
Track	Trace bounding frame of selected job.
Work time	See forecasted running time of selected job.
Clear count	Clear working count of selected job.
Delete	Delete selected file.
Copy to udisk	Copy selected file to flash memory.

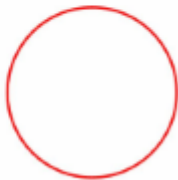
Press **Other** button to enter dialog shown as below.

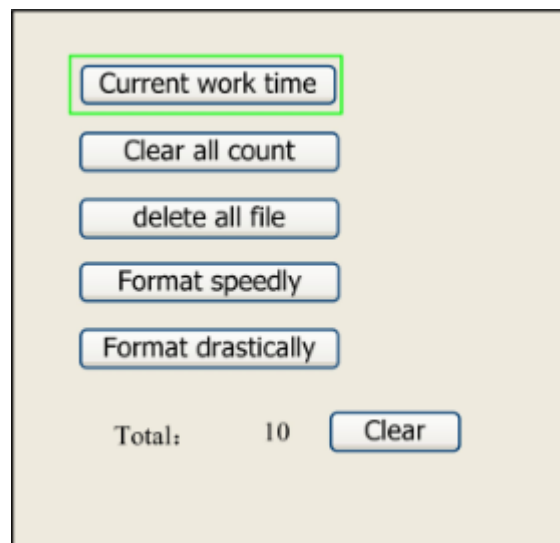

Button	Function
Current work time	See forecasted running time of current job.
Clear all count	Clear working count of all jobs.
Delete all file	Delete all files in memory.
Format speedly	Format system memory quickly, all files in memory will be deleted.

Button	Function
Format drastically	Format system memory drastically, all files in memory will be deleted.
Total	Total working count of all jobs.

Besides system memory, control system support pluggable flash memory. After plug flash memory in, press **Udisk** button to enter dialog shown as below.

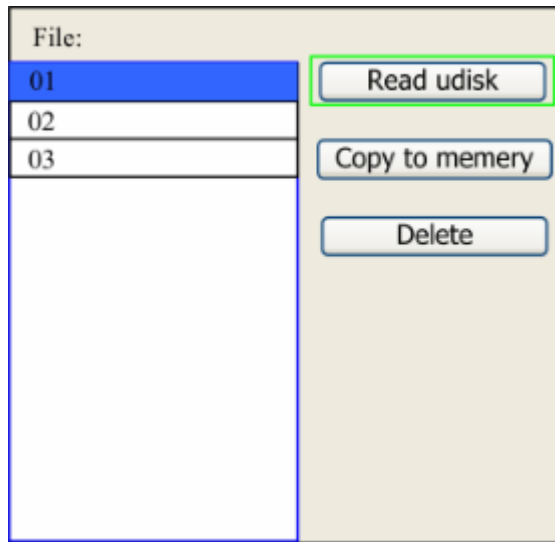

Button	Function
Read udisk	Get list of files on flash memory.
Copy to memory	Copy selected file to system memory.
Delete	Delete selected file.

Control system only supports FAT32/FAT16 filesystem, you should place files in root directory and limit file name length to 8, only ASC-II letters and numbers are allowed in file name. Files copied from system memory to flash will be placed in root directory too.

Settings

In idle mode, press **Z/U** key to enter settings dialog, shown as below.

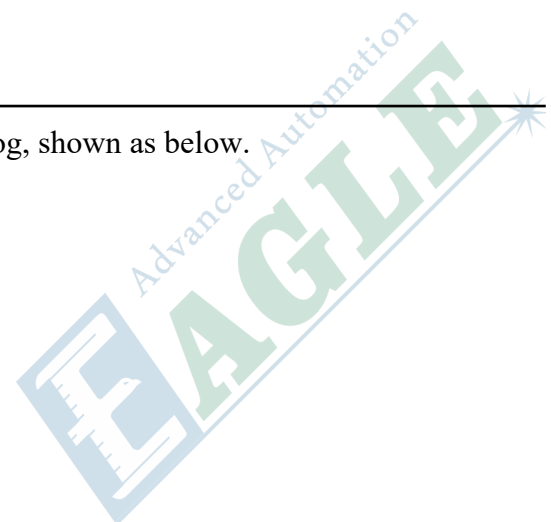

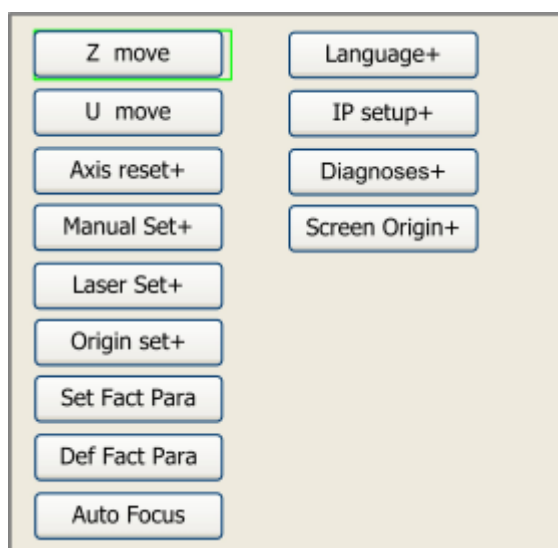

Press **Up** or **Down** key to move cursor, then press **Enter** key to confirm selection.

1. Z move

After selecting Z moving mode, press **Left** or **Right** key to move working table up or down.

2. U move

After selecting U moving mode, press **Left** or **Right** key to rotate U unit clockwise or counter clockwise.

3. Axis reset+

Select and press **Enter** key to enter axis reset dialog, shown as below.

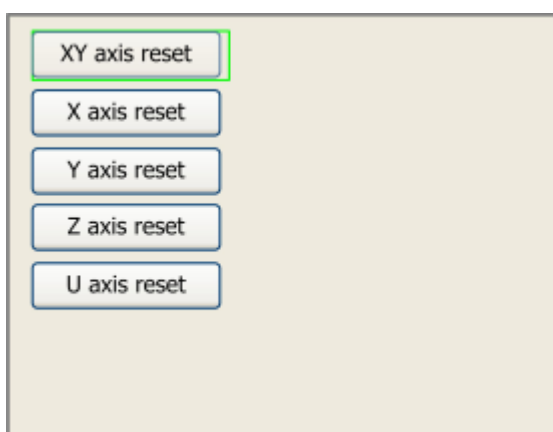

Press **Up** or **Down** key to move cursor, then press **Enter** key to confirm selection to reset specific axis.

4. Manual Set+

Select and press **Enter** key to enter manually moving settings dialog, shown as below.

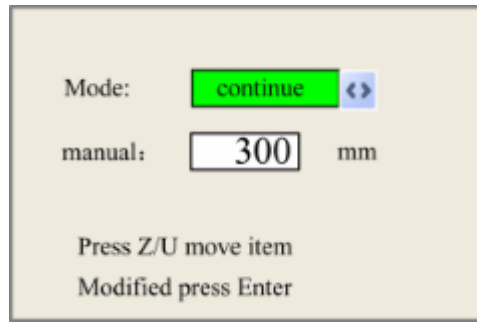

Press **Z/U** key to move cursor, press **Left** or **Right** key to switch mode. When choose **continue** mode, **manual** option becomes invalid, laser head will move continuously when direction key is pressed and hold, and will stop when direction key is released. When choose **manual** mode, you can set step length of manual moving, laser head will move just one step according to your settings when direction key is pressed.

5. Laser Set+

Select and press **Enter** key to enter pulse laser settings dialog, shown as below.

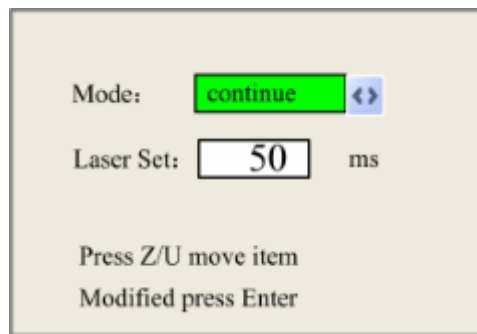

Press **Z/U** key to move cursor, press **Left** or **Right** to switch mode. When choose **continue** mode, **Laser Set** option becomes invalid, laser will be shot continuously when **Pulse** key is pressed and hold, and will be off when **Pulse** key is released. When choose **manual** mode, you can set laser on time, laser will be shot according to your settings when **Pulse** key is pressed.

6. Origin set+

Select and press **Enter** key to enter relative origin settings dialog, shown as below.

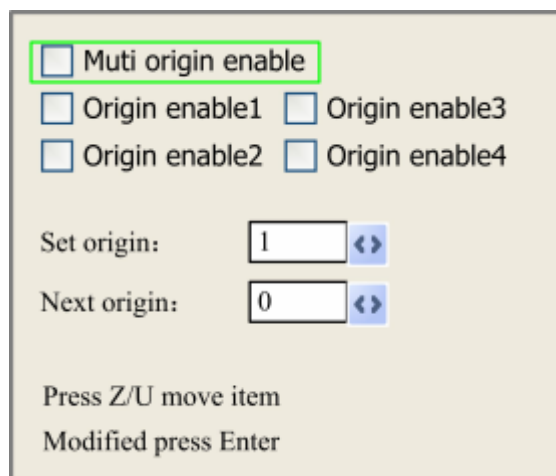

Press **Z/U** key to move cursor, press **Enter** key to check or uncheck option when cursor on any enable option, press **Left** or **Right** key to switch selection when cursor on **Set**

origin or **Next origin** option, and you must press **Enter** key to confirm origin setting on **Set origin** option.

Option	Function
Multiple origins enable	System is in single relative origin mode when this option is unchecked, you should set relative origin by pressing Origin key on control panel. Otherwise, system is in multiple relative origins mode, Origin key becomes invalid, you should choose how many origins you want to use first, then set each one and loop rule to use them repeatedly.
Origin enable1/2/3/4	You can enable or disable four origin options independently by check or uncheck specific one in multiple relative origins mode.
Set origin	Set coordinate of specific relative origin you enabled in multiple relative origins mode, using current coordinate of laser head.
Next origin	Selection will be always 0 in single relative origin mode, stands for the origin set by Origin key on control panel. When system is in multiple relative origins mode, you can choose 1/2/3/4 (if enabled) for using by next job.

7. Set Fact Para

Select and press **Enter** key to trigger password protection dialog, shown as below.



Press **Left** or **Right**, **Up** or **Down** key to move cursor to specific letter, then press **Enter** key to confirm, or press **Esc** key to delete. System will set all current manufacturer and user parameters as factory parameters, and show **Set Fact Para succeed** if password is correct, otherwise, system will show **Wrong Password** and clear input.

Tip:

After regulating all parameters of machine well (including all manufacturer and user parameters), manufacturer can use this function to store the well-regulated parameters, to help users to recover original parameters by selecting **Def Fact Para** when something went wrong.

8. Def Fact Para

Select and press **Enter** key to trigger this function, system will restore all settings you saved before.

9. Auto Focus

When there is a Z axis, and the reset function is enabled, you can select and press **Enter** key to trigger this function.

10.Language+

Select and press **Enter** key to enter language settings dialog, shown as below.



11.IP setup+

Select and press **Enter** to enter network settings dialog, shown as below.

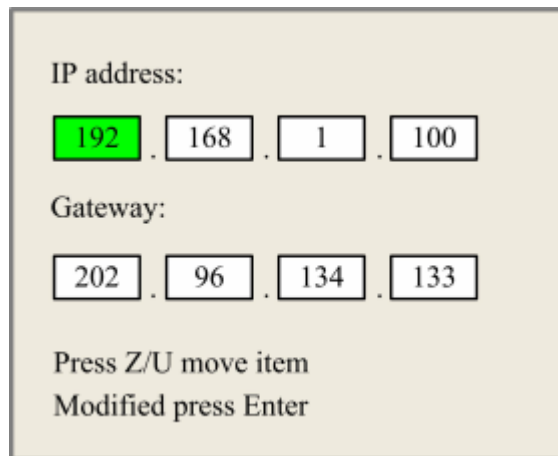

Press **Z/U** key to move cursor, press **Left** or **Right**, **Up** or **Down** key to change values, then press **Enter** key to confirm change.

12.Diagnoses+

Select and press **Enter** key to enter diagnoses dialog, shown as below.

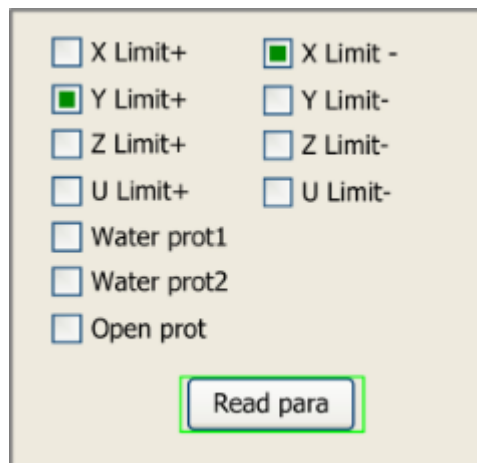

This dialog provide I/O diagnoses information of control system hardware.

13.Screen Origin+

Select and press **Enter** key to enter screen origin settings dialog, shown as below.



Press **Left** or **Right** key to switch option. We suggest setting same screen origin with the software, otherwise, graphics shown on screen will be mirror in X or Y direction with it shown in software, bring some confusion to operator.

Alarm

System will show you some alarm information when something went wrong, for example, water error shown as below.

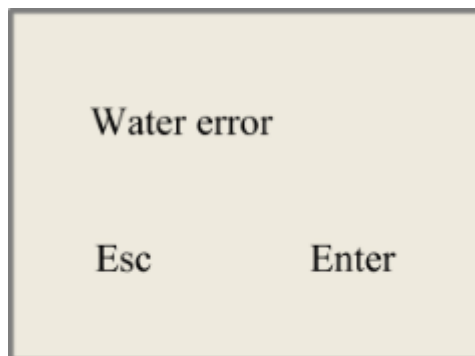

System will run some procedures according to your choice.

Appendix

A

Q & A

Topics:

- *Control System*
- *Laser System*
- *Motion System*

This appendix sums up the most commonly asked questions and answers about the machine.



Control System

1. Can't connect machine to PC.
 - a. Check USB cable connection.
 - b. Check USB port of computer. You can use another USB device to do the test.
 - c. Check initialization is OK or not. If not, the controller should be changed.
 - d. If machine's initialization is OK, use the Origin button to do the self-check. If the self check can not be finished, the controller should be changed.
 - e. If the self-check is finished, check the connection of the ground.
 - f. Check the USB driver is installed correct or not and the virtual serial port is generated correct or not. If not, uninstall the USB driver and reinstall it.
 - g. Check if the output port in software is same with the virtual serial port generated by the computer. If not, change the port setting in the software.
 - h. The spark caused by the problems of high voltage connection of laser tube or the power supply caused interference. Reconnect it or change the power supply.

2. Machine does not initialize.

Check the limit switch of X / Y axis, make sure the cable connected well.

3. Machine working size is not same like parameter.

Check and fit the **Menu Bar > File > Vendor setting**.

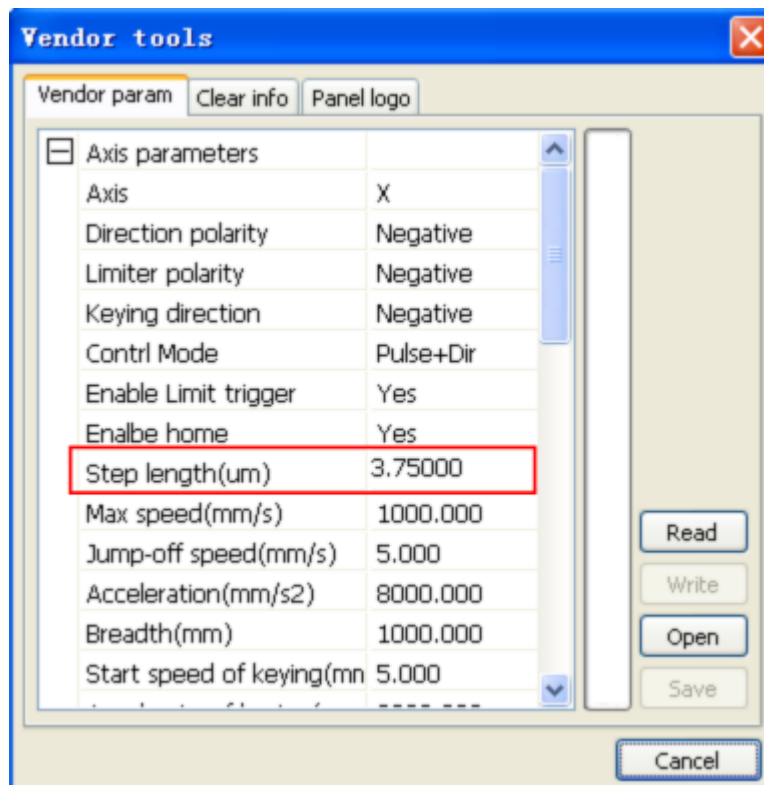

4. Machine run in random when executing the file.
 - a. Check the file is correct or not.
 - b. Make sure you operate the computer correctly.
 - c. Change the controller.
 - d. Check the target you select is in the boundary or not.
 - e. Make sure there is no spark in the laser tube or the power supply.

- f. Check the ground connecting.
- 5. Switch on the machine, cutting head hit in one direction.

If hit X axis left slow(←).

The 8-pin cable from I/O board to X motor and X limit sensor has been broken. Sometimes the limit sensor maybe stuck. Just make it unstuck.

If hit X axis left fast (←←).

The motor driver's direction signal is wrong, should be reversed. Check the parameter of the main board is correct or not.

Change the Direction polarity of Axis X

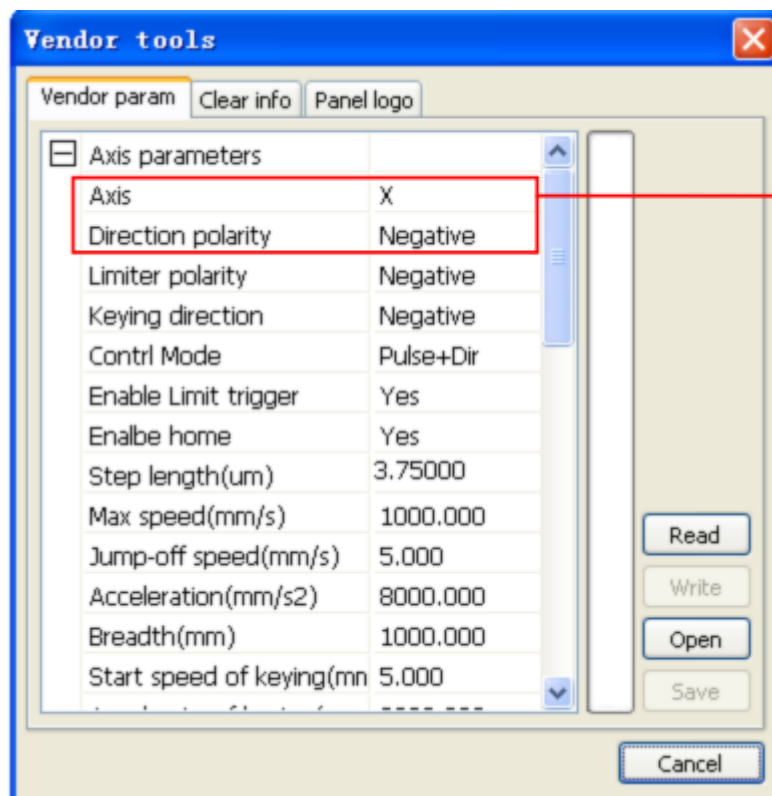

If hit X axis right (→).

The cable of X limit sensor damaged or the sensor's cable has been broken.

If hit the Y axis up(↑).

Check the cable of Y limit sensor and the cable connection with I/O board.

If hit the Y axis down slow(↓).

The cable for Y limit sensor to I/O board has been broken. Sometimes the limit sensor maybe stuck. Just make it unstuck.

If hit the Y axis down fast(↓↓).

The motor driver's direction signal is wrong, should be reversed. Check the parameter of the main board is correct or not.

Change the Direction polarity of Axis Y

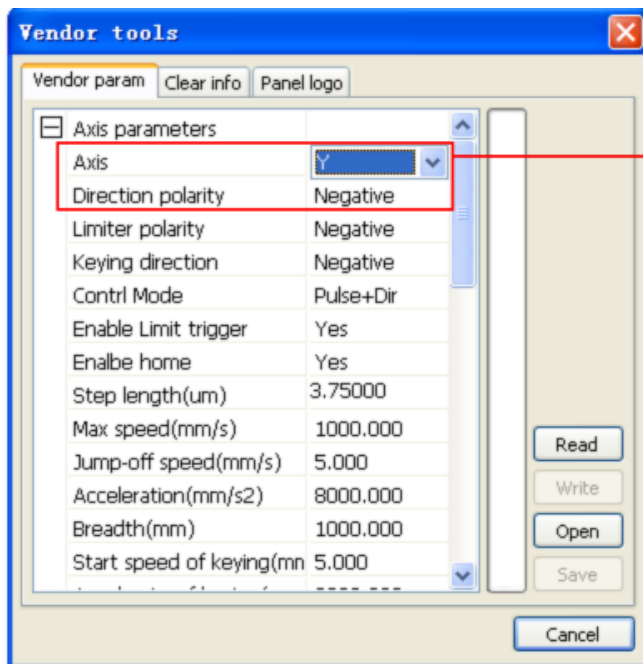

6. After initializing, the machine move abnormally, can't go in right direction or with right speed.

Check all cable connection with motor and motor driver; make sure all cable connected well.

If all cables are connected well, check the motor driver and I/O board. Last chance of damage is the motor.

7. The machine appear automatic initialized, stop, some part be omitted or randomly move when it is working.
 - a. Check the ground connecting. The resistor of the ground must be less than 5Ω .
 - b. Check the connecting of netwire and the contact situation of the button on panel.
 - c. Check if there is a strong interference of strong electricity or strong magnetic.
 - d. Check if there is a screen saver or power saving model(like automatic shutting down or hardware shutting down) on your computer. If there is, cancel all the options.
 - e. Check the parameter of“Layer parameter----Is output”, make sure the option is “Yes”. And make sure you already choose the processing mode

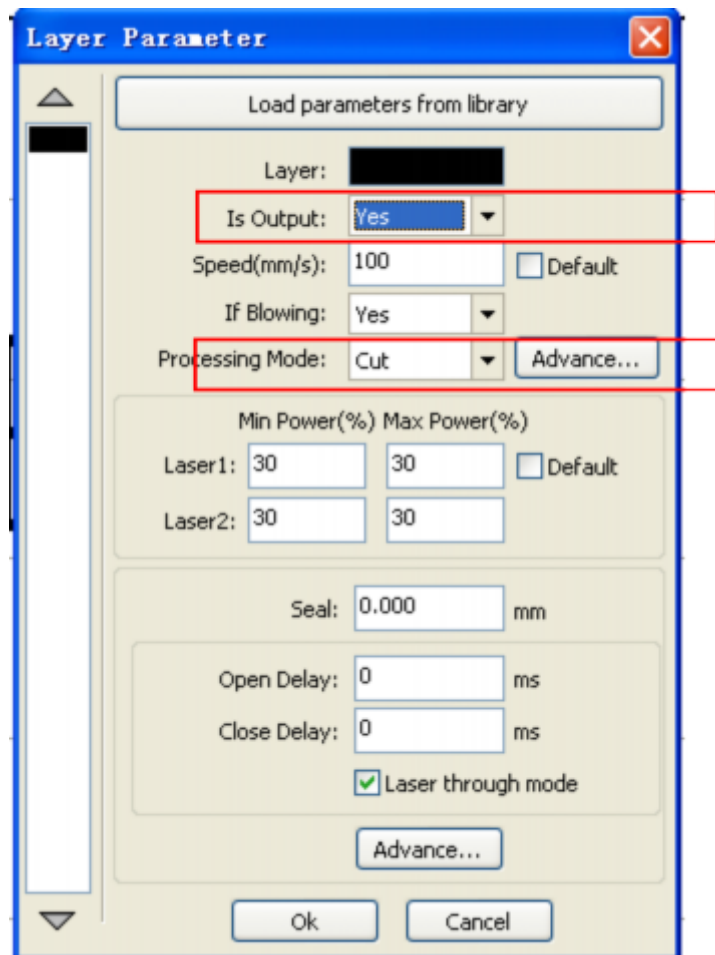

- f. Check the original file is correct or not. If there is a un-close, self-cross, cross or overlap, make it correct and test again.

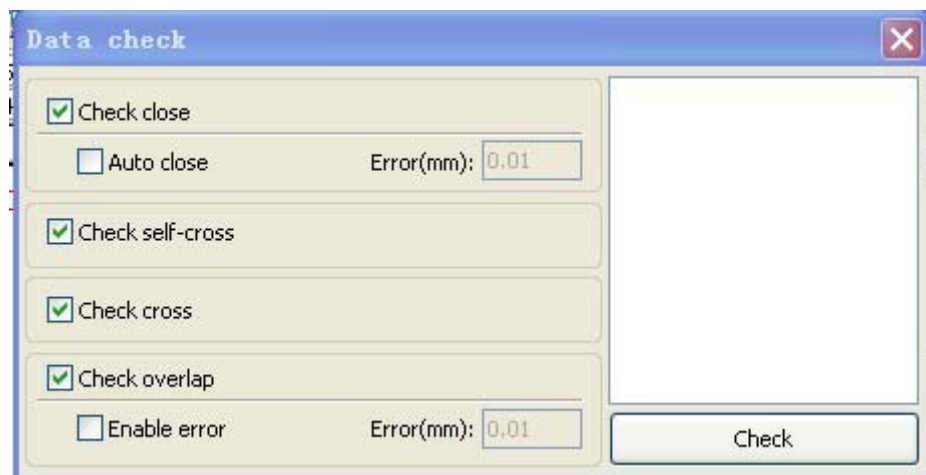

- g. Check if the path calculating correct. Reinstall the software. Sometimes need to reinstall the computer system.
- h. If output the file with another format is no problem. It means something wrong with the file. Output the file again and make a new file.
- i. Check if the laser tube and the power supply spark.
- j. If there is still the problem. Change the main board or the computer then test.
8. The screen does not display and Control panel do not react the operation.

- a. Restart the machine and see if the dolly back to the original position. If not, follow the Step 2.
 - b. If the dolly back to the original position, press the direction buttons and the functional buttons. If all buttons working normally, the liquid crystal display model has been changed.
 - c. If the buttons don't work, the liquid crystal control model has been changed.
 - d. If the screen display normally after changed the liquid crystal control model but the buttons still not working, the button film must be changed.
9. When magnetic sensor damaged, what will happen?

If the sensor always short, the machine will continue working when you open the cover. In this situation the laser maybe hurt the operator.

If the sensor always open, the machine will not work, even we put magnet on the sensor.

With both situations, we should check the problem coming from cable connection or magnetic sensor.

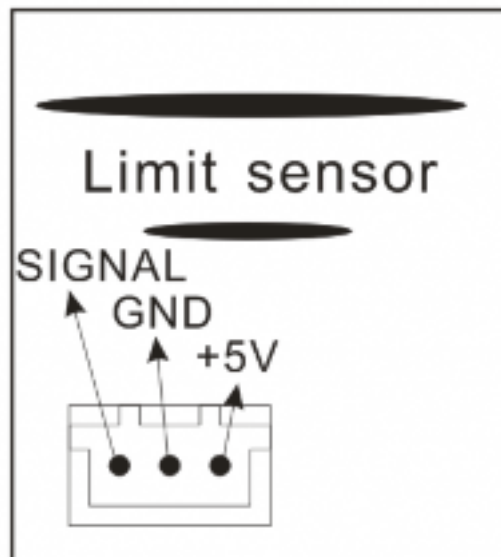

Laser System

1. When switch on the power supply, fuse is burned.
 - Check the AC/DC transformer, maybe shorted in side.
 - Check the power supply of laser, the transformer chip maybe damaged.
2. When switch on the machine, laser always on.
 - a. The light-on signal port connect wrong or the port have problem. Change the light-on signal port.
 - b. The panel has problem, change the panel.
 - c. The power supply has problem. Change the power supply.
3. The cutting line is wider than usual.
 - Check the focus distance is right or not.

4. Cutting ability decreased than before.

Check the mirror or lens is damaged or not.

Check the laser beam is in center of all mirror and lens.

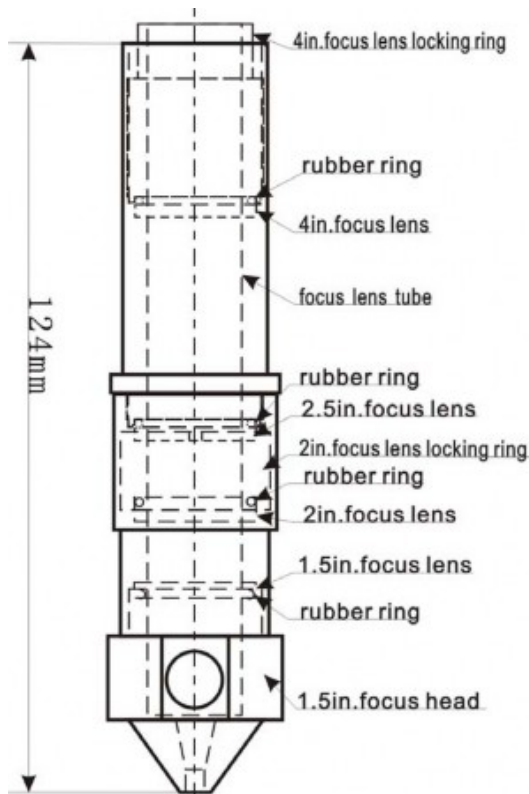

1. The standard focal length of this focus lens tube is 5mm
2. This focus lens tube can only install one focus lens, the convex of the lens upward, can install 1.5, 2, 2.5, 4 inch focus lens.
3. Light-hole diameter is 3mm
4. The air flow adjusting valve is screwed on the 1.5in. focus head.
5. The lifting range is 30mm. After remove 4in. focus lens locking ring, the lifting range is 32mm.
6. The opening mouth direction of focus lens locking ring upward.
7. All the lens have rubber ring, the diameter is 20mm, $D=1.5\text{mm}$, when install, first put the ring to the right place, and then wring tight.

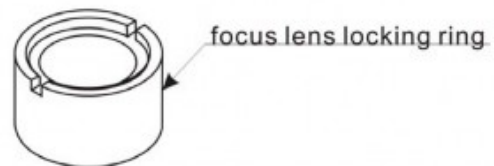

Motion System

1. Cutting head move abnormally or movement is not stable.

Check the cable from motor driver to motor.

Check the motor driver setting (subdivision & ampere).

If all cable and setting are ok, mostly is the motor damaged.

2. Motor generates noise when working.

Check the installation of mechanical structure and motor driver.

If motor driver setting is ok, probably the motor damaged.

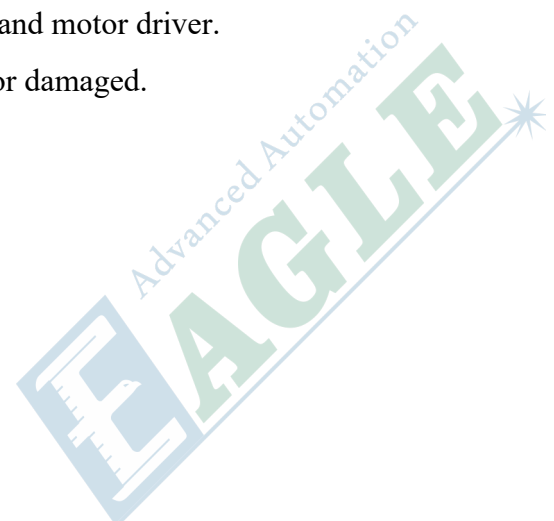

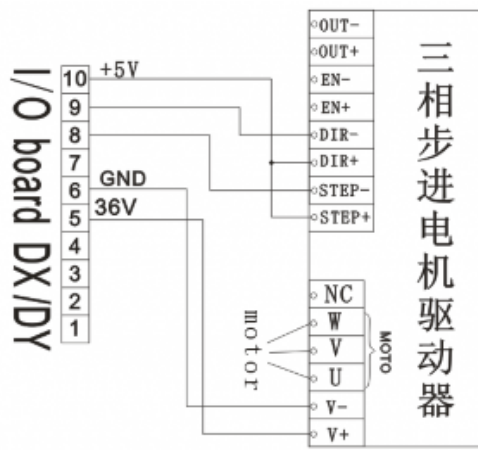

Three-phase step motor driver

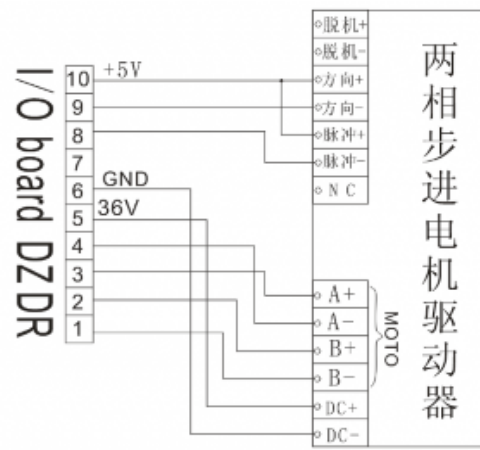

Two-phase step motor driver

Appendix

B

Electronic Connections

Topics:

- *Servo Motor*
- *Step Motor*



Servo Motor

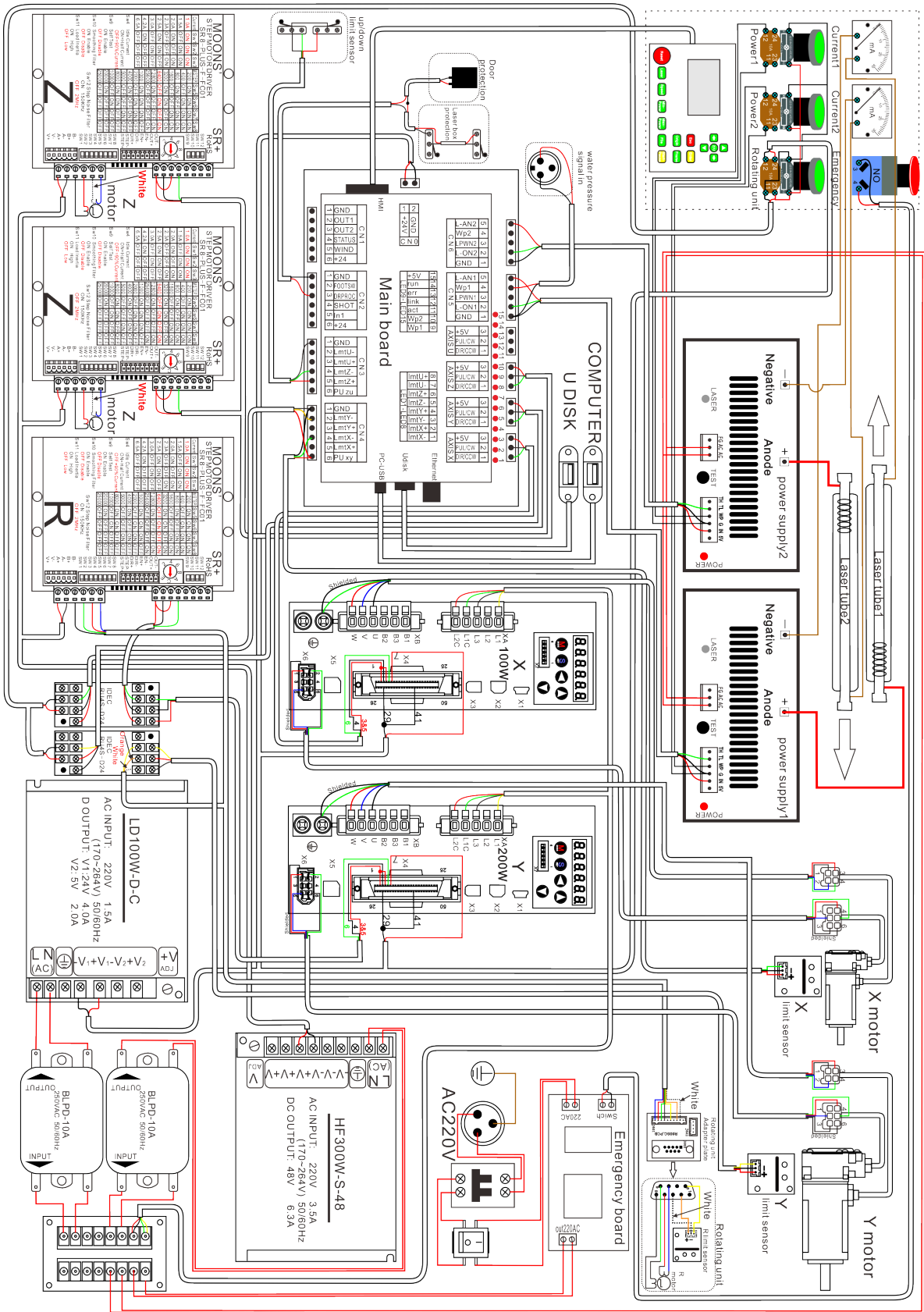

Step Motor

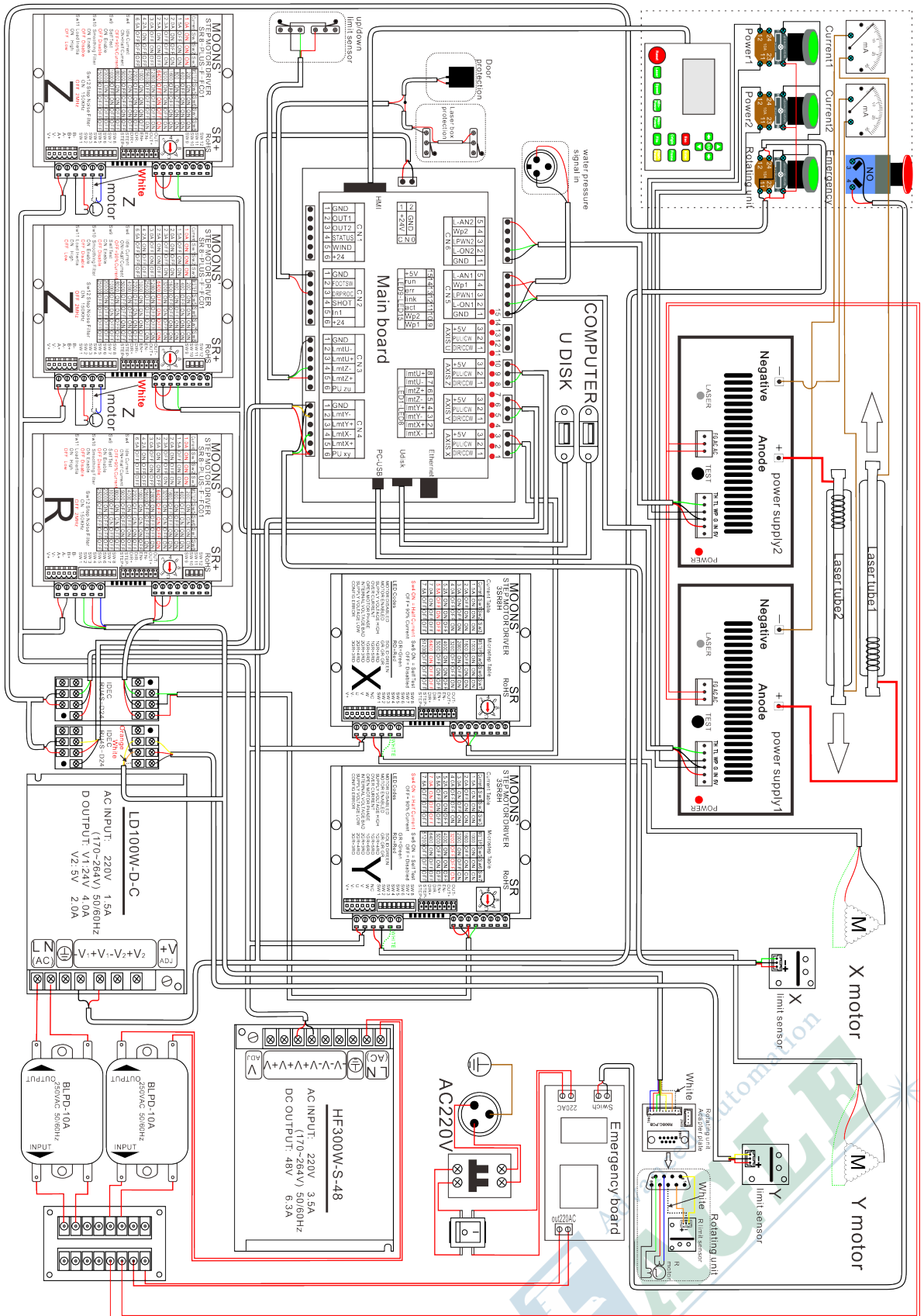

Revision History

Revision	Publication Date	Note
1.0	12/27/2017	Initial version.
1.1	06/23/2020	Restruct manual contents.
1.2	11/11/2020	Rename manual, add safety chapter.



